

25

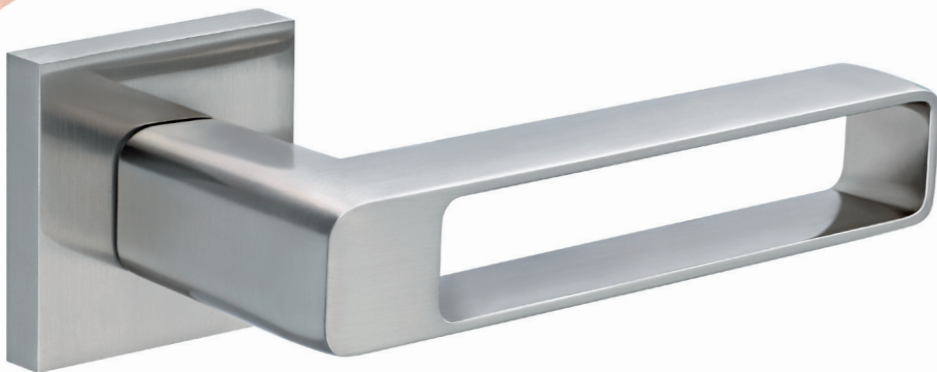

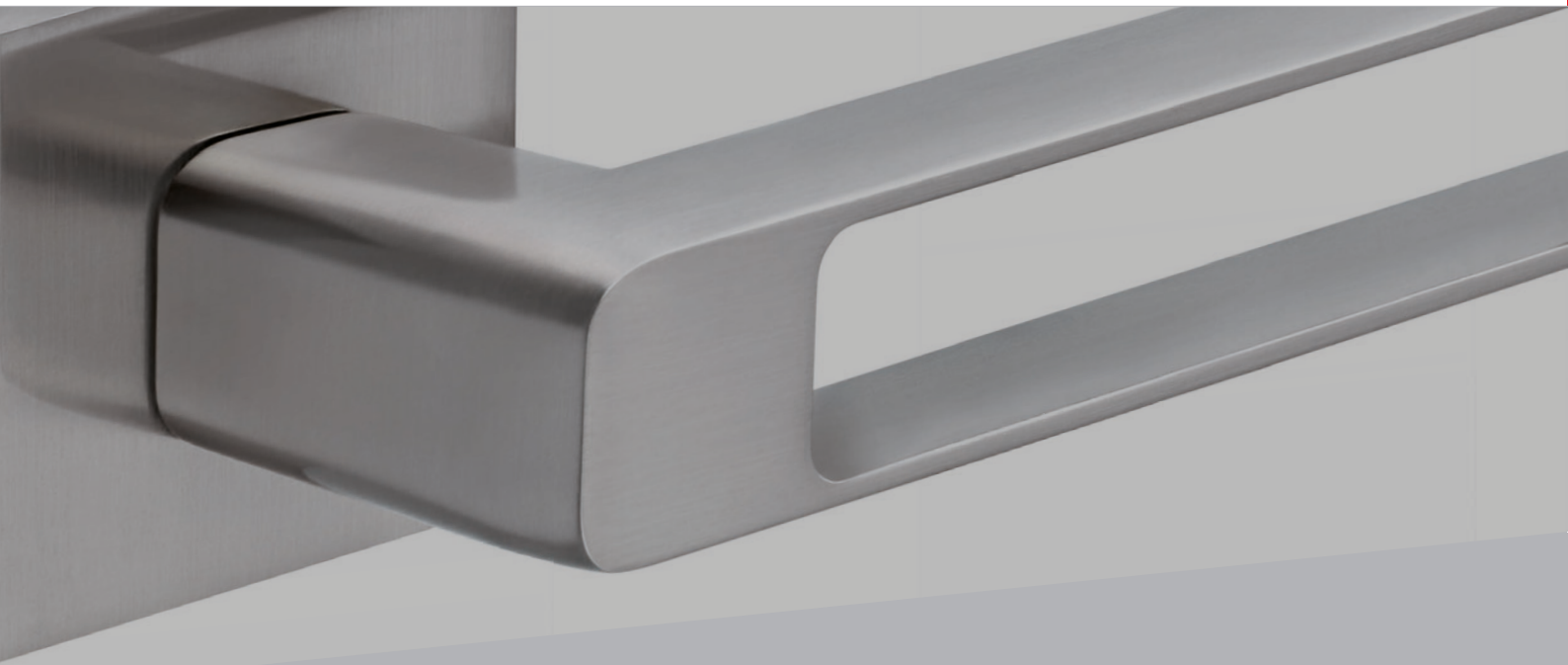

Vážení zákazníci, vážení obchodní priatelia,
v spoločnosti COBRA sa už 25 rokov držíme úspešných modelov a pritom stále hľadáme nové.
V novom katalógu s jubilejným poradovým číslom 25 sme pre vás pripravili množstvo noviniiek.
Úplne nové je aj usporiadanie katalógu, ktorý je po novom zoradený podľa použitých povrchov tak,
aby ste mali lepšiu predstavu o ponúkanom sortimente tovaru. Nielen vďaka tomu vám môžeme slúbiť,
že pre vás bude naozaj zábavou vyberať si z našej novej ponuky.



Jakub Mulac

Obchodný riaditeľ

4

6

14

20

24

32

Rýchla orientácia

Nerez

Alena-S
Basic-S
Bianca-R
Giussy-R
Giussy-R economy
Giussy-S
Giussy-S economy
Loft
Loft-R
Loft-R economy
Nela-S
Nova-R
Nova-S
Orca-S
Paola
Paola-R
Paola-R economy
Pavla-S
Plaza
Plaza-R
Plaza-S
Quibic-S
Ride-R
Sali
Sali-R
Sali-R economy
Sali-S
Ufo
Ufo-R
Ufo-R economy
Vision
Vision-R
Vision-R economy
Vision-R oval
Vision-S
Vision-S economy
RI nerez

Guľa

Star
Step
Luna

Okenné kovania

Vision

Chróm matný

Alexis
Alexis-R
Bella-S
Blade-R
Dalí-R
Dune-R
Element-R
Jerome-R
Laura
Laura-R
Mega-R
Mega-S
Milena
Milena-R
Neo-S
Orion
Orion-R
Ponte-S
Presso-S
Puro-S
Quadra-R
Spoon-R
Vali-R
Vista-S

Guľa

Brit
Victory
Vittoria

Okenné kovania

Alt-Wien
Elegant

Chróm lesklý

Blade-R
Dalí-R
Laura
Laura-R
Morphos-S
Presso-S
Quadra-R
Spoon-R
Sveva
Sveva+
Titan
Titan+

Guľa

Vittoria

Okenné kovania

Alt-Wien
Elegant

Nikel matný

Alexis
Alexis-R
Beata-S
Blade-R
Dalí-R
Dune-R
Element
Element-R
Fap
Fap-R
Giussy
Laura
Laura-R
Maja
Milena
Milena-R
Morphos-S
Orion
Orion-R
Orion-R Economy
Presso-S
Roxia-R
Sandra-R
Sina
Sina-R
Spoon-R
Vali-R
Vista-S
Zeus
Zeus-R Economy
C101+
Sveva
Sveva+
Titan
Titan+

Guľa

Brit
Victory
Sfera
Vittoria

Okenné kovania

Elegant

Nikel čierny

Bella-S
Neo-S
Ponte-S
Puro-S

34

**Chróm lesk./
Nikel matný**

Agatha-R
Gabri
Gabri-S
Giusy-R
Nathalia-R
Nicol-R
Nicol-S
Sharon-R
Sharon-S
Viki-R
Viki-S

Gula
Victory
Balkónová kľučka

38

**Kované
kovanie**

Berlin
Bremen
Dortmund
Hamburg
Hamburg-R
Hamburg-R+
Imst-R
Imst+
Manheim
Regen
Wolfsburg

Okenné kovania
Hamburg
Manheim

42

**Bronz
česaný**

Alt-Wien
Atlantis
Dea
Dea-R
Donna-R
Elegant
Florence
Giusy-R
Ikarus
Kristina
Kristina-R
Laura
Laura-R
Milena
Münster
Mystic-R
Rafaela-S
Sina
Sina-R
Swing
Swing-R
Venezia
Alt-Wien
Alt-Wien+
C101+
Sveva
Sveva+
Titan
Titan+

Gula
Victory
Vittoria
Okenné kovania
Alt-Wien
Elegant

50

**Mosadz
leštená**

Alt-Wien
Atlantis
Elegant
Ikarus
Kristina
Kristina-R
Laura
Laura-R
Münster
Quadra-R
Alt-Wien+
Alt-Wien
Sveva
Sveva+
Titan
Titan+

Gula
Victory
Sfera
Georgian
Diamante
Vittoria
Okenné kovania
Alt-Wien
Elegant

56

Staromosadz

Alt-Wien
Elegant
Okenné kovania
Alt-Wien
Elegant

58

**Strieborný
elox**

Element
Element-R
Element-S
Flat
Flat-R
Flat-S
Giusy
Giusy-R
Giusy-S
Mira-R
Monet
Monet-R
Plaza-R
Plaza-S
Universal
Universal-R
Herold
Herold+
R101
R101+
R111
R111+
Slim 2
Tower
Tower+

Rozety
Rozeta Herold
Okenné kovania
Univerzal
Balkónová kľučka ST4

64

**Nerezový
elox**

Laura Economy
Element
Element-R
Element-S
Flat
Flat-R
Flat-S
Giusy
Giusy-R
Giusy-S
Plaza-R
Plaza-S
R101
R101+
R111
R111+
Slim 2
Tower
Tower+

70

**Bronzový
elox**

Element
Element-R
Element-S
Flat
Flat-R
Flat-S
Giusy
Giusy-R
Giusy-S
Mira-R
Monet
Monet-R
Universal
Universal-R
Herold
Herold+
R101
R101+
R111
R111+
Slim 2
Tower
Tower+

Rozety
Rozeta Herold
Okenné kovania
Univerzal
Balkónová kľučka ST3

76

**Biela
economy**

Laura
Michaela

76

**Zlatá
economy**

Laura
Michaela

76

**Sivá
economy**

Laura
Michaela

78

**Doplňkový
sortiment**

Rozety
Balkónové kľučky
Madla
Úchyty
Vložky cylindrické
Zámky zadlabavacie
WC sety
Záklopky dverí
Skrýty pant
Závesy
Stavače dverí
Zarážky dverí
Zarážky
Dverové sklapy
Piktogramy
Číslica
Vhody na dopisy
Pridavný retiazka
Kukátko
Klepadla
Konzoly policové
Háčky a vešiaky
Držiak na kvetináč
Petlice na dvere
Posuvný systém
Vetracie mriežky
Dverné zatvárače
Schodiskový systém
Cobra deťom
Krbové náradie
Panikové kovania

Symbols

	Kovanie pre objekty		WC – kúpeľňa		Bezpečnostný certifikát 2 – trieda bezpečnosti č. 2 podľa ČSN EN 1906)
	Gulôčkové ložisko		Záruka 3 roky		Bezpečnostný certifikát 2 – trieda bezpečnosti č. 2 podľa ČSN EN 1906)
	Protipožiarne		Záruka 5 rokov		Bezpečnostný certifikát 3 – trieda bezpečnosti č. 3 podľa ČSN EN 1906)
	Pružina		Záruka 10 rokov		Bezpečnostný certifikát 4 – trieda bezpečnosti č. 4 podľa ČSN EN 1906)
	Telefonické informácie		BB – Dózický kľúč		Ochranné kovania
	Rýchla montáž		PZ – Cylindrická vložka		Novinky sú označené červenou farbou

Tabuľka povrchov doplnkov

	Nerez		Mosadz lesk/mat		Kované kovanie a čierna
	Chróm matný		Žltý pozink		Strieborný elox
	Chróm lesklý		Pozinkované		Bronzový elox
	Nikel matný		Pomosadz		Biela
	Bronz česaný		Bronz		Hnedá
	Mosadz lesklá		Pobronzované		Sivá a strieborná
	Mosadz matná		Poniklované		Zlatá

Symbols typov prevedenia interiérových kľučiek a bezpečnostných kovaní

	BB Kľučka/kľučka Otvor pre dózický kľúč		Wc Kľučka/kľučka – Wc – kúpeľňa		PZ RE Kľučka pravá/guľa Otvor pre cylindrickú vložku
	PZ Kľučka/kľučka Otvor pre cylindrickú vložku		PZ LI Kľučka ľavá/guľa Otvor pre cylindrickú vložku		B Balkónová kľučka Otvor pre cylindrickú vložku
	K PZ LI Kľučka/kľučka Otvor pre cylindrickú vložku		PZL Kľučka ľavá/kľučka Otvor pre cylindrickú vložku		M PZ LI Kľučka ľavá/madlo Otvor pre cylindrickú vložku
	K PZ RE Kľučka/kľučka Otvor pre cylindrickú vložku		PZR Kľučka pravá/kľučka Otvor pre cylindrickú vložku		M PZ RE Kľučka pravá/madlo Otvor pre cylindrickú vložku

Tabuľka štandardných roztečí

Rozteč – norma	A	D	CZ-SK	H	SLO-HR	PL	UA	RO
Kľúč	90	72	72/90	55/90	90	72/90	85/90	72/90
Cylindrická vložka	88	72	72/90	55/90	90	72/90	85/90	72/90
Cylindrická vložka bezpečnostná	88	92/72	90	90/92	90	90/92	85/90	72/90
WC	90	78	72	55/90	90	60/72	72/90	72/90
WC štvorhran	7x7	8x8	6x6	8x8	6x6	4x4		6x6

(Vzdialenosť od stredu otvoru pre kľučku otáčania kľúča). Ponúkame rozteče podľa všetkých hlavných európskych noriem.

Verzie kovania

Kovanie vám ponúkame v štítovej a rozetovej verzii, ďalej podľa otvoru vo verzii BB – dózický kľúč, PZ – cylindrická vložka, WC súprava a B – balkónová kľučka. WC súprava sa používa do kúpeľní a na toalety a z vonkajšej strany je vybavená drážkou na otvorenie v prípade nutnosti.

V prípade variantov kovania guľa/kľučka, držadlo/kľučka je potrebné určiť orientáciu kľučky (ĽAVÁ/PRAVÁ). V prípade bezpečnostného kovania je potrebné určiť orientáciu kľučky aj pri vyhotovení kľučka/kľučka (ĽAVÁ/PRAVÁ). Guľa môže byť pevná aj otočná. Ponúkame vám tiež variant štítu bez otvoru. Drobný materiál sa dá objednať samostatne.

Možnosť objednania

- objednaním v našom e-shope na adrese www.cobrask.sk,
- e-mailovou objednávkou na adrese obchod@cobrask.sk,
- v sieti našich obchodných partnerov

Spôsob odberu tovaru

- zásielkovou službou

Všetky zmeny technického charakteru sú vyhradené. / Uvedené základné ceny bez DPH platia od 1. 3. 2015 do vydania nového katalógu. Pri výrobku sú uvedené ceny s aktuálnou výškou DPH 20 % s výhradou jej zmeny.

Aktuálne ceny s DPH nájdete na www.cobrask.sk
Právo na tlačové chyby vyhradené. Skutočná farba alebo vzhľad výrobku, ako aj jeho rozmery sa môžu líšiť.

Dverové kovanie je certifikované podľa ČSN EN 1906 a je určené na montáž na štandardné interiérové dvere do celkovej hmotnosti 40 kg bez zatvárača. Montáž odporúčame zveriť odbornej firme.

Údržba

Na čistenie od prachu alebo iných nečistôt použite jemnú handričku, ktorá je suchá alebo navlhčená vo vode. Nepoužívajte brúsne a chemické prípravky. Ich použitím môžete kovanie poškodiť. Nerezové kovanie spĺňa najvyššie nároky odolnosti proti mechanickému poškodeniu a pri jeho údržbe sa môžu použiť aj vhodné čistiace prípravky. Jeho inštaláciu odporúčame v prevádzkach, ktoré musia spĺňať hygienické podmienky.

Navštívte naše webové stránky

www.cobrask.sk



06

Nerez

7	Alena-S	9	Paola-R	12	Vision
7	Basic-S	9	Paola-R economy	12	Vision-R
7	Bianca-R	9	Pavla-S	12	Vision-R oval
7	Giusy-R	10	Plaza	12	Vision-R economy
7	Giusy-R economy	10	Plaza-R	12	Vision-S
7	Giusy-S	10	Plaza-S	13	Vision-S economy
8	Giusy-S economy	10	Quibic-S	13	RI nerez
8	Loft	10	Ride-R		
8	Loft-R	10	Sali	13	Gula
8	Loft-R economy	11	Sali-R	13	Star
8	Nela-S	11	Sali-R economy	13	Step
8	Nova-R	11	Sali-S	13	Luna
9	Nova-S	11	Ufo	13	Okenné kovania
9	Orca-S	11	Ufo-R	13	Vision
9	Paola	11	Ufo-R economy		



Alena-S



BB/PZ	23,60	28,30
WC	31,60	37,90
PZ-LI/RE	31,60	37,90



137



55

Basic-S



BB/PZ	35,60	42,70
WC	43,60	52,30
PZ-LI/RE	43,60	52,30



120



55

Bianca-R



BB/PZ	31,60	37,90
WC	39,60	47,50
PZ-LI/RE	39,60	47,50



130



55

Giusy-R



BB/PZ	23,60	28,30
WC	31,60	37,90
PZ-LI/RE	31,60	37,90



127



55

Giusy-R economy



BB/PZ	15,60	18,70
WC	19,60	23,50
PZ-LI/RE	21,60	25,90



127



55

Giusy-S



BB/PZ	29,60	35,50
WC	37,60	45,10
PZ-LI/RE	37,60	45,10



127



55

Giusy-S economy



BB/PZ	19,60	23,50
WC	23,60	28,30
PZ-LI/RE	25,60	30,70



127



55

Loft



BB/PZ	15,60	18,70
WC	21,60	25,90
PZ-LI/RE	23,60	28,30



225

40 140

Loft-R



BB/PZ	23,60	28,30
WC	31,60	37,90
PZ-LI/RE	31,60	37,90



BB/PZ	155,60	186,70
WC	195,60	234,70
PZ-LI/RE	195,60	234,70



BB/PZ	103,60	124,30
WC	159,60	191,50
PZ-LI/RE	159,60	191,50



140



55

50 mm pre

Loft-R economy



BB/PZ	10,00	12,00
WC	15,60	18,70
PZ-LI/RE	17,60	21,10



125



55

Nela-S



BB/PZ	35,60	42,70
WC	43,60	52,30
PZ-LI/RE	43,60	52,30



120



55

Nova-R



BB/PZ	23,60	28,30
WC	31,60	37,90
PZ-LI/RE	31,60	37,90



132



52

Nova-S



BB/PZ	27,60	33,10
WC	35,60	42,70
PZ-LI/RE	35,60	42,70



132



55

Orca-S



BB/PZ	31,60	37,90
WC	39,60	47,50
PZ-LI/RE	39,60	47,50



125



55

Paola



BB/PZ	15,60	18,70
WC	21,60	25,90
PZ-LI/RE	23,60	28,30



225

40

140

Paola-R



BB/PZ	27,60	33,10
WC	35,60	42,70
PZ-LI/RE	35,60	42,70



140



55

Paola-R economy



BB/PZ	10,00	12,00
WC	15,60	18,70
PZ-LI/RE	17,60	21,10



140



55

Pavla-S



BB/PZ	29,60	35,50
WC	37,60	45,10
PZ-LI/RE	37,60	45,10



135



55

Plaza



BB/PZ	15,60	18,70
WC	21,60	25,90
PZ-LI/RE	23,60	28,30



Plaza-R



BB/PZ	25,60	30,70
WC	33,60	40,30
PZ-LI/RE	33,60	40,30

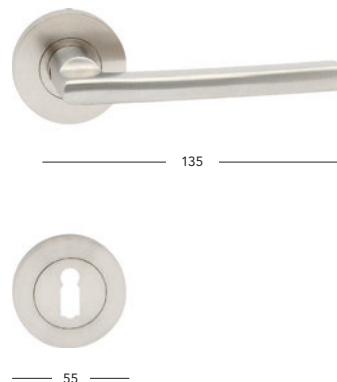

Plaza-S



BB/PZ	29,60	35,50
WC	37,60	45,10
PZ-LI/RE	37,60	45,10

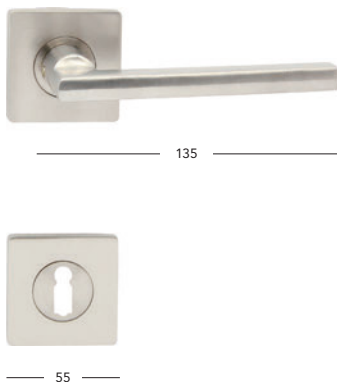

Qubic-S



BB/PZ	31,60	37,90
WC	39,60	47,50
PZ-LI/RE	39,60	47,50

nerez matný, nerez lesklý

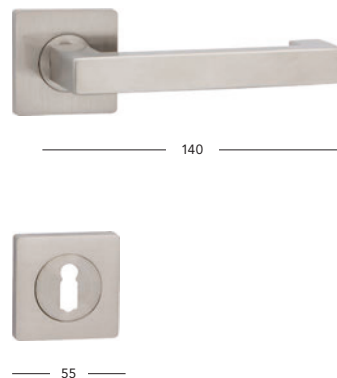

Ride-R



BB/PZ	27,60	33,10
WC	35,60	42,70
PZ-LI/RE	35,60	42,70

nerez matný, nerez lesklý

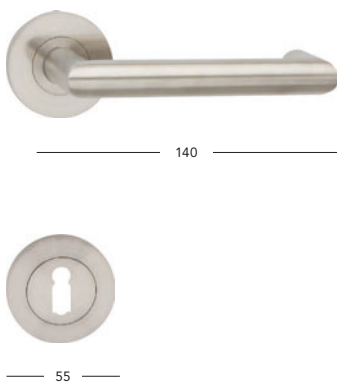

Sali



BB/PZ	15,60	18,70
WC	21,60	25,90
PZ-LI/RE	23,60	28,30



Sali-R



BB/PZ	19,60	23,50
WC	27,60	33,10
PZ-LI/RE	27,60	33,10



135



55

Sali-R economy



BB/PZ	10,00	12,00
WC	15,60	18,70
PZ-LI/RE	17,60	21,10



135



55

Sali-S



BB/PZ	23,60	28,30
WC	31,60	37,90
PZ-LI/RE	31,60	37,90



135



55

Ufo



BB/PZ	15,60	18,70
WC	21,60	25,90
PZ-LI/RE	23,60	28,30



225

40 140

Ufo-R



BB/PZ	21,60	25,90		BB/PZ	163,60	196,30
WC	29,60	35,50		WC	199,60	239,50
PZ-LI/RE	29,60	35,50		PZ-LI/RE	199,60	239,50

	BB/PZ	119,60	143,50
	WC	167,60	201,10
	PZ-LI/RE	167,60	201,10



140



55

50 mm pre

Ufo-R economy



BB/PZ	10,00	12,00
WC	15,60	18,70
PZ-LI/RE	17,60	21,10



140



55

Vision-R



BB/PZ	19,60	23,50
WC	27,60	33,10
PZ-LI/RE	27,60	33,10



BB/PZ	186,80	224,20
WC	223,20	267,80
PZ-LI/RE	223,20	267,80



BB/PZ	126,40	151,70
WC	178,80	214,60
PZ-LI/RE	178,80	214,60



135



55

50 mm pre

Vision



BB/PZ	15,60	18,70
WC	21,60	25,90
PZ-LI/RE	23,60	28,30



225

40

140

Vision-R oval



BB/PZ	17,60	21,10
WC	21,60	25,90
PZ-LI/RE	27,60	33,10



BB/PZ	181,20	217,40
WC	217,60	261,10
PZ-LI/RE	217,60	261,10



BB/PZ	126,40	151,70
WC	178,80	214,60
PZ-LI/RE	178,80	214,60

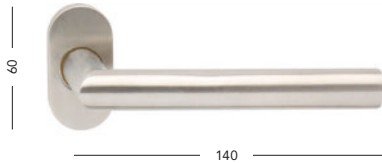

60

140



60

32

Vision-R economy



BB/PZ	10,00	12,00
WC	15,60	18,70
PZ-LI/RE	17,60	21,10



135



55

Vision-S



BB/PZ	27,60	33,10
WC	35,60	42,70
PZ-LI/RE	35,60	42,70



135



55

Vision-S economy



BB/PZ	14,80	17,80
WC	20,80	25,00
PZ-LI/RE	22,80	27,40

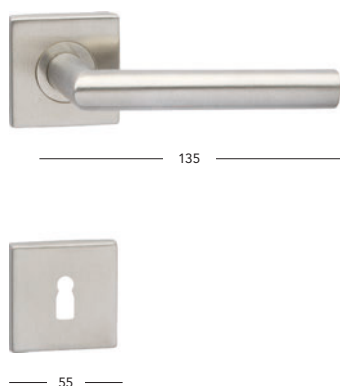

RI nerez



PZ L/R	82,00	98,40
M PZ-LI/RE	82,00	98,40

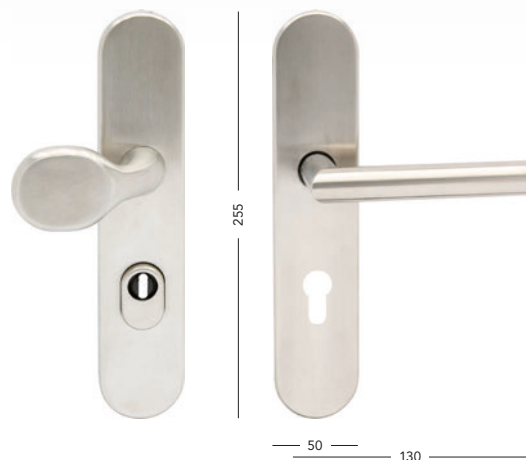

Guľa pevná



Star		
obj. číslo	B41690E16	
cena ks	23,20	27,80

Step		
obj. číslo	C4189E6K55	
cena ks	23,20	27,80

Luna		
obj. číslo	C4199E6K55	
cena ks	23,20	27,80

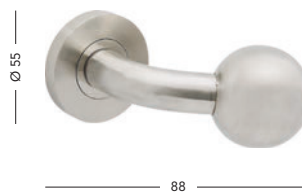

Na vyžiadanie samostatná guľa bez rozety alebo guľa otočná.

Okenné kovania Vision



Oliva		
obj. číslo	C2183E07	
cena	10,00	12,00

Pololiva		
obj. číslo	C2183E08	
cena	9,20	11,00

Balkónová kľučka		
obj. číslo	C2183E06	
cena	10,00	12,00

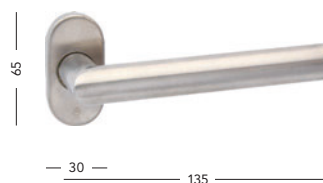
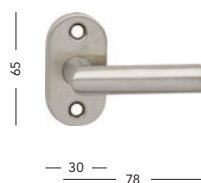
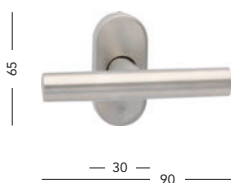

14

Chróm matný

- | | | | |
|----|-----------|-----------|-----------------------|
| 15 | Alexis | 18 | Puro-S |
| 15 | Alexis-R | 18 | Quadra-R |
| 15 | Bella-S | 18 | Spoon-R |
| 15 | Blade-R | 18 | Vali-R |
| 15 | Dalí-R | 19 | Vista-S |
| 15 | Dune-R | | |
| 16 | Element-R | 19 | Gula |
| 16 | Jerome-R | 19 | Brit |
| 16 | Laura | 19 | Victory |
| 16 | Laura-R | 19 | Vittoria |
| 16 | Mega-R | 19 | Okenné kovania |
| 16 | Mega-S | 19 | Alt-Wien |
| 17 | Milena | 19 | Elegant |
| 17 | Milena-R | | |
| 17 | Neo-S | | |
| 17 | Orion | | |
| 17 | Orion-R | | |
| 18 | Ponte-S | | |
| 18 | Presso-S | | |



Alexis



BB/PZ	14,40	17,30
WC	18,40	22,10
PZ-LI/RE	20,40	24,50

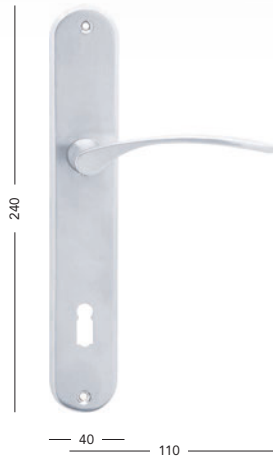

Alexis-R



BB/PZ	15,60	18,70
WC	19,60	23,50
PZ-LI/RE	21,60	25,90

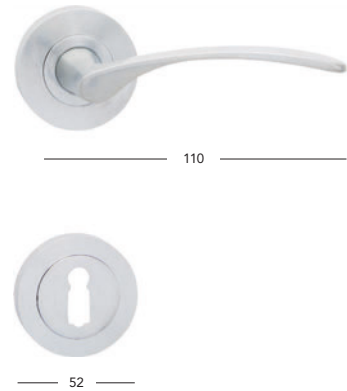

Bella-S



BB/PZ	39,60	47,50
WC	43,60	52,30
PZ-LI/RE	45,60	54,70

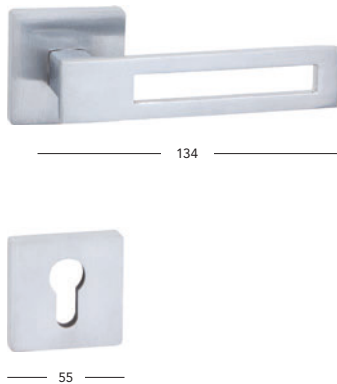

Blade-R



BB/PZ	90,00	108,00
WC	102,00	122,40
PZ-LI/RE	102,00	122,40

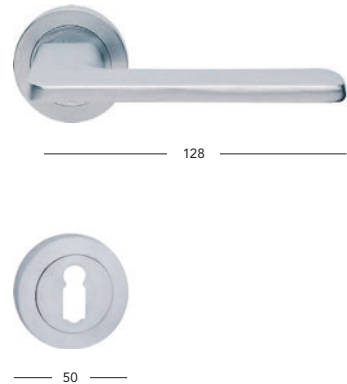

Dalí-R



BB/PZ	90,00	108,00
WC	102,00	122,40
PZ-LI/RE	102,00	122,40

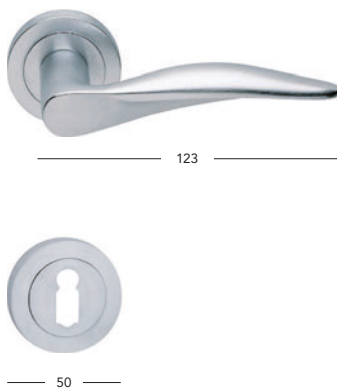

Dune-R



BB/PZ	89,20	107,00
WC	101,20	121,40
PZ-LI/RE	101,20	121,40

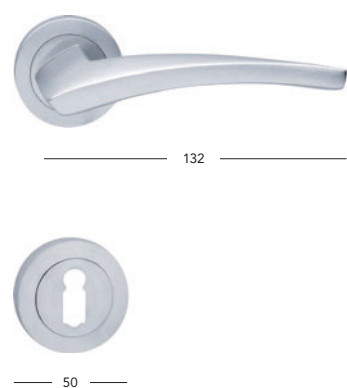

Element-R



BB/PZ	24,80	29,80
WC	28,80	34,60
PZ-LI/RE	30,80	37,00

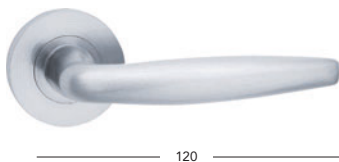

Jerome-R



BB/PZ	20,80	25,00
WC	24,80	29,80
PZ-LI/RE	26,80	32,20



Laura



BB/PZ	14,80	17,80
WC	18,80	22,60
PZ-LI/RE	20,80	25,00

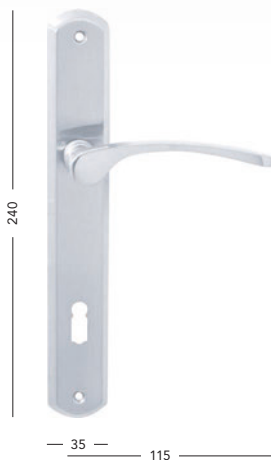

Laura-R



BB/PZ	17,60	21,10
WC	21,60	25,90
PZ-LI/RE	23,60	28,30



Mega-R



BB/PZ	27,60	33,10
WC	31,60	37,90
PZ-LI/RE	33,60	40,30



Mega-S



BB/PZ	31,60	37,90
WC	35,60	42,70
PZ-LI/RE	37,60	45,10

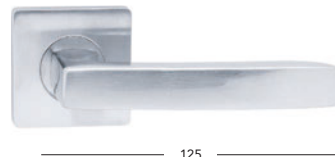

Milena



BB/PZ	13,60	16,30
WC	17,60	21,10
PZ-LI/RE	19,60	23,50

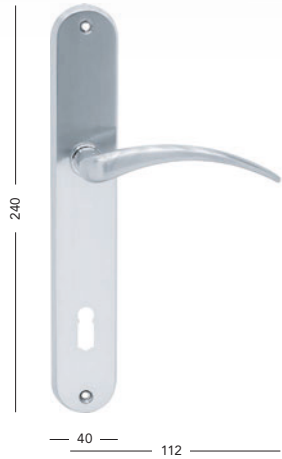

Milena-R



BB/PZ	13,60	16,30
WC	17,60	21,10
PZ-LI/RE	19,60	23,50

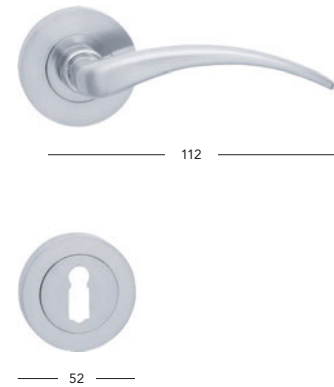

Neo-S



BB/PZ	39,60	47,50
WC	43,60	52,30
PZ-LI/RE	45,60	54,70

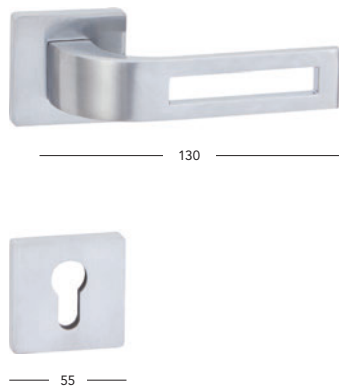

Orion



BB/PZ	17,20	20,60
WC	21,20	25,40
PZ-LI/RE	23,20	27,80

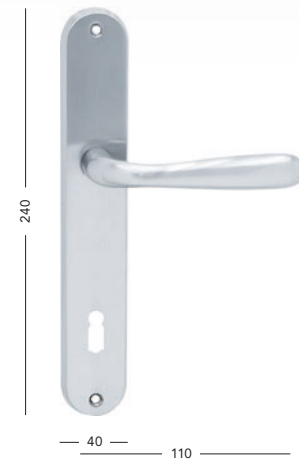

Orion-R



BB/PZ	17,20	20,60
WC	21,20	25,40
PZ-LI/RE	23,20	27,80

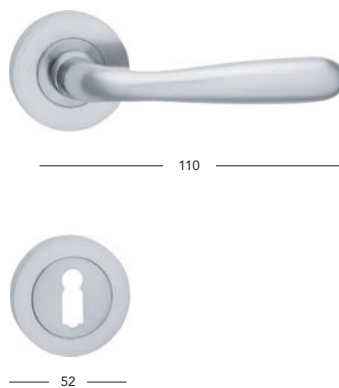

Ponte-S



BB/PZ	35,60	42,70
WC	39,60	47,50
PZ-LI/RE	41,60	49,90

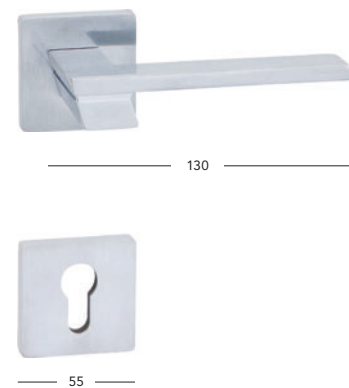

Presso-S

BB/PZ	39,20	47,00
WC	43,20	51,80
PZ-LI/RE	45,20	54,20



133



50

Puro-S

BB/PZ	39,60	47,50
WC	43,60	52,30
PZ-LI/RE	45,60	54,70



145



55

Quadra-R

BB/PZ	102,00	122,40
WC	114,00	136,80
PZ-LI/RE	114,00	136,80
BUK, HRUŠKA, WENGE		



139



50

Spoon-R

BB/PZ	98,00	117,60
WC	110,00	132,00
PZ-LI/RE	110,00	132,00



147



50

Vali-R

BB/PZ	35,60	42,70
WC	39,60	47,50
PZ-LI/RE	41,60	49,90



125



52

Vista-S

BB/PZ	50,00	60,00
WC	54,00	64,80
PZ-LI/RE	56,00	67,20



130



55

Guľa pevná



Brit
obj. číslo C417919H55P
cena ks 15,80 19,00

Victory
obj. číslo C415919602
cena ks 15,40 18,50

Guľa otočná

Vittoria 8 mm
obj. číslo M25919X00
cena pár 50,90 61,10

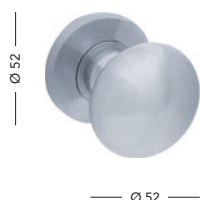
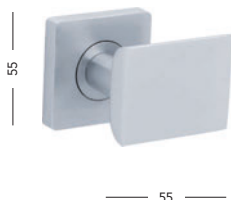

Na vyžiadanie samostatná guľa bez rozety alebo guľa otočná.

Okenné kovania Alt-Wien



Oliva
obj. číslo P06459X60B
cena 12,00 14,40

Pololiva
obj. číslo P06449X00B
cena 10,80 13,00

Pololiva veľká
obj. číslo P06469X00N
cena 12,40 14,90

Balkónová kľučka
obj. číslo P06479X00B
cena 15,60 18,70

Rozvora
obj. číslo P06439X00B
cena 14,80 17,80

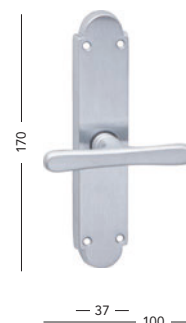
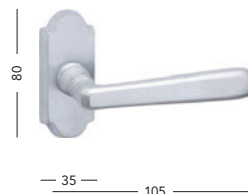
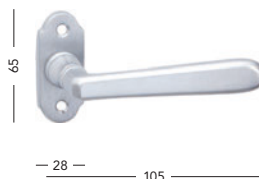
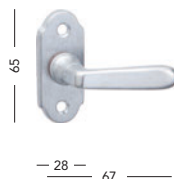
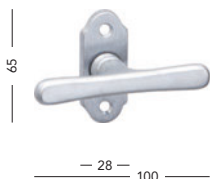

Okenné kovania Elegant



Oliva
obj. číslo P01029X00B
cena 10,00 12,00

Pololiva
obj. číslo P01049X00B
cena 9,20 11,00

Pololiva veľká
obj. číslo P01069X00N
cena 11,60 13,90

Balkónová kľučka
obj. číslo P01059X00B
cena 13,20 15,80

Rozvora
obj. číslo P01039X00B
cena 12,40 14,90

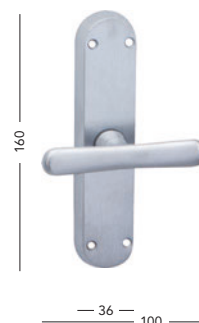
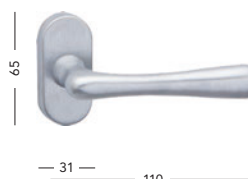
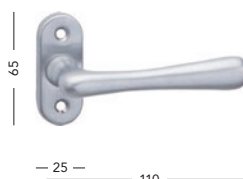
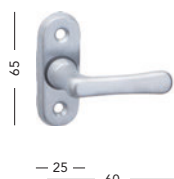
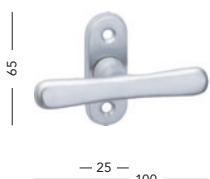

20

Chróm lesklý

- 21 Blade-R
- 21 Dalí-R
- 21 Laura
- 21 Laura-R
- 21 Morphos-S
- 22 Presso-S
- 22 Quadra-R
- 22 Spoon-R
- 22 Sveva
- 22 Sveva+
- 23 Titan
- 23 Titan+

- 23 Guľa**
- 23 Vittoria
- 23 Okenné kovania**
- 23 Alt-Wien
- 23 Elegant



Blade-R



BB/PZ	90,00	108,00
WC	102,00	122,40
PZ-LI/RE	102,00	122,40



128



50

Dalí-R



BB/PZ	90,00	108,00
WC	102,00	122,40
PZ-LI/RE	90,00	108,00



123



50

Laura



BB/PZ	14,80	17,80
WC	18,80	22,60
PZ-LI/RE	20,80	25,00



240

35

115

Laura-R



BB/PZ	17,60	21,10
WC	21,60	25,90
PZ-LI/RE	23,60	28,30



115



52

Morphos-S



BB/PZ	115,60	138,70
WC	127,40	153,10
PZ-LI/RE	127,40	153,10



127



50

Presso-S

BB/PZ	39,20	47,00
WC	43,20	51,80
PZ-LI/RE	43,20	51,80



133



50

Quadra-R

BB/PZ	102,00	122,40
WC	114,00	136,80
PZ-LI/RE	114,00	136,80

BUK, HRUŠKA, WENGE



139



50

Spoon-R

BB/PZ	98,00	117,60
WC	110,00	132,00
PZ-LI/RE	110,00	132,00



147



52

Sveva

PZ L/R	47,60	57,10
K PZ LI/RE	47,60	57,10



260



47

122

Sveva+

PZ L/R	75,60	90,70
K PZ LI/RE	75,60	90,70



260

47

122

Titan

PZ L/R	47,60	57,10
K PZ LI/RE	47,60	57,10



260



50

133

Titan+



PZ L/R 75,60 90,70
K PZ LI/RE 75,60 90,70

Gulá otočná

Vittoria 8 mm

obj. číslo FB25915X00
cena pár 50,80 60,90



Okenné kovania Alt-Wien



Oliva

obj. číslo P06455X60B
cena 12,00 14,40

Pololiva

obj. číslo P06445X00B
cena 10,80 13,00

Pololiva velká

obj. číslo P06465X00N
cena 12,40 14,90

Balkónová klučka

obj. číslo P06475X00B
cena 15,60 18,70

Rozvora

obj. číslo P06435X00B
cena 14,80 17,80

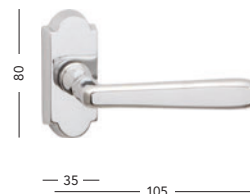
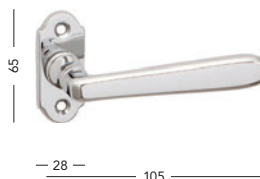
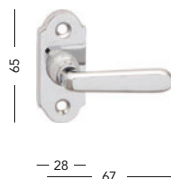

Okenné kovania Elegant



Oliva

obj. číslo P01025X00B
cena 10,00 12,00

Pololiva

obj. číslo P01045X00B
cena 9,20 11,00

Pololiva velká

obj. číslo P01065X00B
cena 11,60 13,90

Balkónová klučka

obj. číslo P01055X00B
cena 13,20 15,80

Rozvora

obj. číslo P01035X00N
cena 12,40 14,90

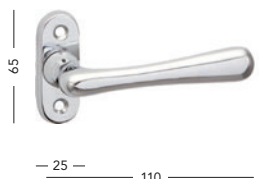
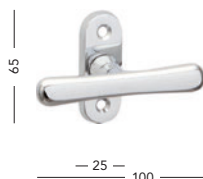

24

Nikel matný

25	Alexis	28	Roxia-R
25	Alexis-R	29	Sandra-R
25	Beata-S	29	Sina
25	Blade-R	29	Sina-R
25	Dalí-R	29	Spoon-R
26	Dune-R	29	Vali-R
26	Element	29	Vista-S
26	Element-R	30	Zeus
26	Fap	30	Zeus-R Economy
26	Fap-R	30	C101+
26	Gussy	30	Sveva
27	Laura	30	Sveva+
27	Laura-R	31	Titan
27	Maja	31	Titan+
27	Milena	31	Gula
27	Milena-R	31	Brit
28	Morphos-S	31	Victory
28	Orion	31	Sfera
28	Orion-R	31	Vittoria
28	Orion-R Economy	31	Okenné kovania Elegant



Alexis



BB/PZ	14,40	17,30
WC	18,40	22,10
PZ-LI/RE	20,40	24,50



Alexis-R



BB/PZ	15,60	18,70
WC	19,60	23,50
PZ-LI/RE	21,60	25,90



Beata-S



BB/PZ	21,60	25,90
WC	25,60	30,70
PZ-LI/RE	27,60	33,10

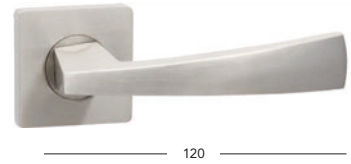

Blade-R



BB/PZ	94,00	112,80
WC	106,00	127,20
PZ-LI/RE	106,00	127,20

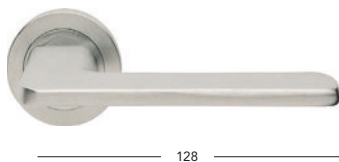

Dalí-R



BB/PZ	94,00	112,80
WC	106,00	127,20
PZ-LI/RE	106,00	127,20



Dune-R

BB/PZ	105,20	126,20
WC	117,20	140,60
PZ-LI/RE	117,20	140,60



132



50

Element

BB/PZ	24,80	29,80
WC	28,80	34,60
PZ-LI/RE	30,80	37,00



240

40 120

Element-R

BB/PZ	24,80	29,80
WC	28,80	34,60
PZ-LI/RE	30,80	37,00



120



52

Fap

BB/PZ	15,60	18,70
WC	19,60	23,50
PZ-LI/RE	21,60	25,90



240

35 114

Fap-R

BB/PZ	18,80	22,60
WC	22,80	27,40
PZ-LI/RE	24,80	29,80



114



52

Giusy

BB/PZ	19,60	23,50
WC	23,60	28,30
PZ-LI/RE	25,60	30,70



240

40 115

Laura



BB/PZ	14,80	17,80
WC	18,80	22,60
PZ-LI/RE	20,80	25,00



Laura-R



BB/PZ	17,60	21,10
WC	21,60	25,90
PZ-LI/RE	23,60	28,30



Maja



BB/PZ	13,60	16,30
WC	17,60	21,10
PZ-LI/RE	19,60	23,50



Milena



BB/PZ	13,60	16,30
WC	17,60	21,10
PZ-LI/RE	19,60	23,50

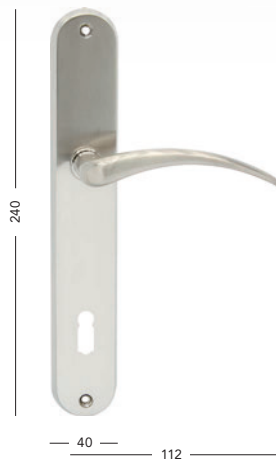

Milena-R



BB/PZ	13,60	16,30
WC	17,60	21,10
PZ-LI/RE	19,60	23,50



Morphos-S

BB/PZ	115,60	138,70
WC	127,60	153,10
PZ-LI/RE	127,60	153,10



127



50

Orion

BB/PZ	17,20	20,60
WC	21,20	25,40
PZ-LI/RE	23,20	27,80

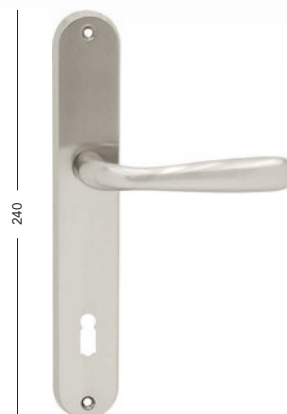

240

40 110

Orion-R

BB/PZ	18,40	22,10
WC	22,40	26,90
PZ-LI/RE	24,40	29,30



110



52

**Orion-R
economy**

BB/PZ	12,00	14,40
WC	15,80	19,20
PZ-LI/RE	18,00	21,60



117



50

Presso-S

BB/PZ	39,20	47,00
WC	43,20	51,80
PZ-LI/RE	45,20	54,20



133



50

Roxia-R

BB/PZ	20,80	25,00
WC	24,80	29,80
PZ-LI/RE	26,80	32,20



120



52

Sandra-R



BB/PZ	15,20	18,20
WC	19,20	23,00
PZ-LI/RE	21,20	25,40



110



52

Sina



BB/PZ	19,20	23,00
WC	23,20	27,80
PZ-LI/RE	25,20	30,20

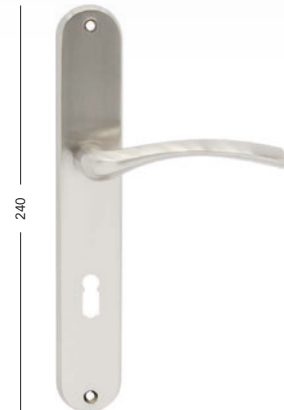

240

40 117

Sina-R



BB/PZ	25,20	30,20
WC	29,20	35,00
PZ-LI/RE	31,20	37,40



117



52

Spoon-R



BB/PZ	98,00	117,60
WC	110,00	132,00
PZ-LI/RE	110,00	132,00



147



52

Vali-R



BB/PZ	35,60	42,70
WC	39,60	47,50
PZ-LI/RE	41,60	49,90



125



52

Vista-S



BB/PZ	50,00	60,00
WC	54,00	64,80
PZ-LI/RE	56,00	67,20



130



55

Zeus

BB/PZ	11,60	13,90
WC	15,60	18,70
PZ-LI/RE	17,60	21,10

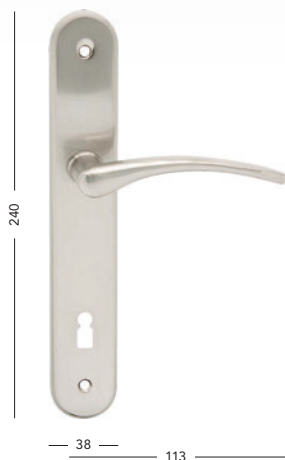
**Zeus-R economy**

BB/PZ	12,40	14,90
WC	16,40	19,70
PZ-LI/RE	18,40	22,10

**C101+**

K PZ-LI/RE	25,20	30,20
------------	-------	-------

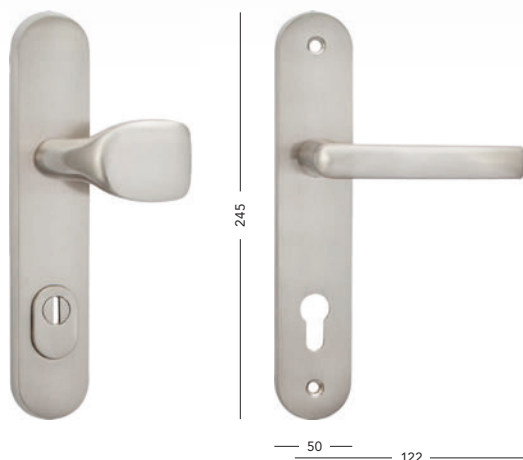
**Sveva**

PZ L/R	47,60	57,10
K PZ LI/RE	47,60	57,10

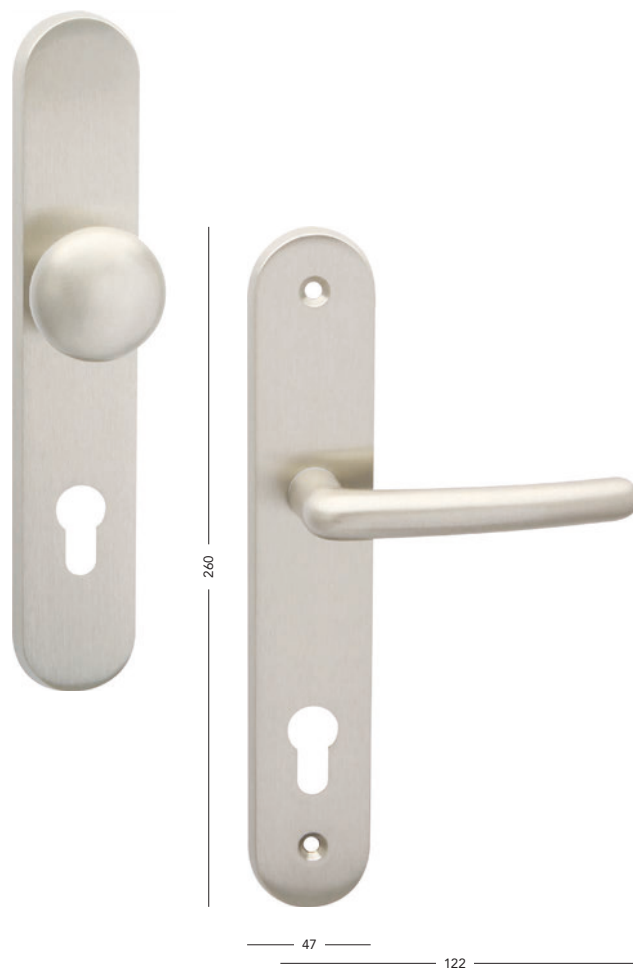
**Sveva+**

PZ L/R	75,60	90,70
K PZ LI/RE	75,60	90,70



Titan



PZ L/R 47,60 57,10
K PZ LI/RE 47,60 57,10

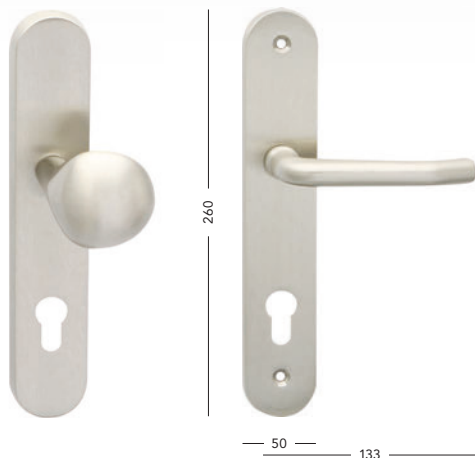

Titan+



PZ L/R 75,60 90,70
K PZ LI/RE 75,60 90,70

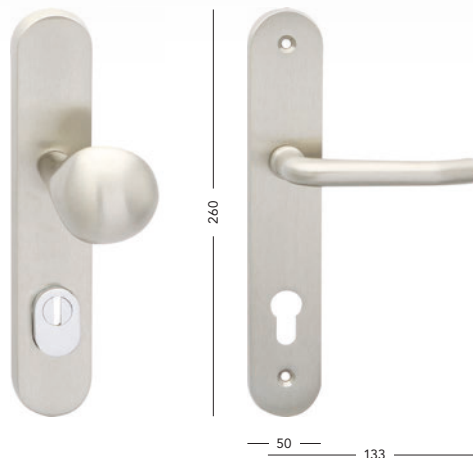

Guľa pevná



Brit
obj. číslo C417916H55P
cena ks 15,80 19,00

Victory
obj. číslo C415916602
cena ks 15,40 18,50

Sfera na závit 8 mm
obj. číslo FB031216X00
cena ks 30,00 36,00

Sfera 8 mm
obj. číslo FB031206X00
cena pár 59,60 71,50

Vittoria 8 mm
obj. číslo FB25916X00
cena pár 55,20 66,30

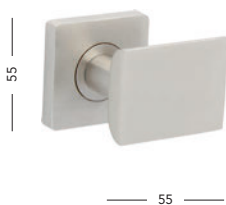

Na vyžiadanie samostatná guľa bez rozety alebo guľa otočná.

Guľa otočná

Okenné kovania Elegant

Oliva
obj. číslo P01026X00B
cena 10,00 12,00

Pololiva
obj. číslo P01046X00B
cena 9,20 11,00

Pololiva veľká
obj. číslo P01066X00N
cena 11,60 13,90

Balkónová kľučka
obj. číslo P01056X00B
cena 13,20 15,80

Rozvora
obj. číslo P01036X00B
cena 12,40 14,90

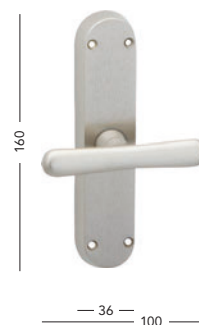
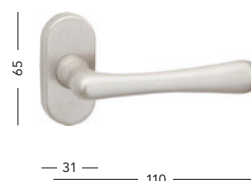
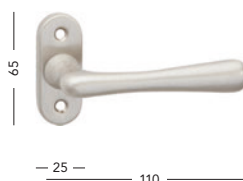
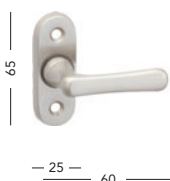
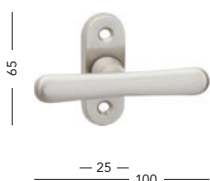

32

Nikel černý

33 Bella-S
33 Neo-S
33 Ponte-S
33 Puro-S



Bella-S



BB/PZ	39,60	47,50
WC	43,60	52,30
PZ-LI/RE	45,60	54,70



134



55

Neo-S



BB/PZ	39,60	47,50
WC	43,60	52,30
PZ-LI/RE	45,60	54,70



130



55

Ponte-S



BB/PZ	35,60	42,70
WC	39,60	47,50
PZ-LI/RE	41,60	49,90



130



55

Puro-S



BB/PZ	39,60	47,50
WC	43,60	52,30
PZ-LI/RE	45,60	54,70

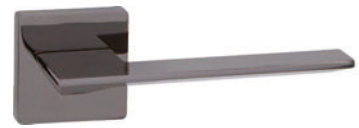

145



55

34

Chróm lesklý / Nikel matný

- 35 Agatha-R
- 35 Gabri
- 35 Gabri-S
- 35 Gussy-R
- 36 Nathalia-R
- 36 Nicol-R
- 36 Nicol-S
- 36 Sharon-R
- 36 Sharon-S
- 37 Viki-R
- 37 Viki-S

- 37 Guľa**
- 37 Victory



Agatha-R



BB/PZ	23,20	27,80
WC	27,20	32,60
PZ-LI/RE	28,80	34,60



125



52

Gabri-S



BB/PZ	25,60	30,70
WC	29,60	35,50
PZ-LI/RE	33,60	40,30



125



55

Gabri



BB/PZ	19,60	23,50
WC	23,60	28,30
PZ-LI/RE	25,60	30,70



240

42 125

Giusy-R



BB/PZ	23,20	27,80
WC	27,20	32,60
PZ-LI/RE	29,20	35,00



115



52

Nathalia-R

BB/PZ	27,60	33,10
WC	31,60	37,90
PZ-LI/RE	33,60	40,30



130



52

Nicol-R

BB/PZ	23,20	27,80
WC	27,20	32,60
PZ-LI/RE	29,20	35,00



120



52

Nicol-S

BB/PZ	27,20	32,60
WC	31,20	37,40
PZ-LI/RE	33,20	39,80



120



55

Sharon-R

BB/PZ	27,60	33,10
WC	31,60	37,90
PZ-LI/RE	33,60	40,30



125



52

Sharon-S

BB/PZ	31,60	37,90
WC	35,60	42,70
PZ-LI/RE	37,60	45,10



125



55

Viki-R

BB/PZ	23,20	27,80
WC	27,20	32,60
PZ-LI/RE	29,20	35,00



125



52

Viki-S

BB/PZ	25,20	30,20
WC	29,20	35,00
PZ-LI/RE	31,20	37,40



125



55

Guľa pevná**Victory**

obj. číslo C415917602
cena ks 15,40 18,50



Ø 52

Ø 52

Na vyžiadanie samostatná guľa bez rozety alebo guľa otočná.

38

Kované kovania

- 39 Berlin
- 39 Bremen
- 39 Dortmund
- 39 Hamburg
- 40 Hamburg-R
- 40 Hamburg-R+
- 40 Imst-R
- 40 Imst+
- 40 Mannheim
- 41 Regen
- 41 Wolfsburg

- 41 Okenné kovania**
- 41 Hamburg
- 41 Mannheim



Berlin

BB/PZ	103,60	124,30
PZ-LI/RE	111,60	133,90



Bremen

BB/PZ	35,60	42,70
PZ-LI/RE	43,60	52,30



Hamburg

BB/PZ	71,60	85,90
PZ-LI/RE	79,60	95,50

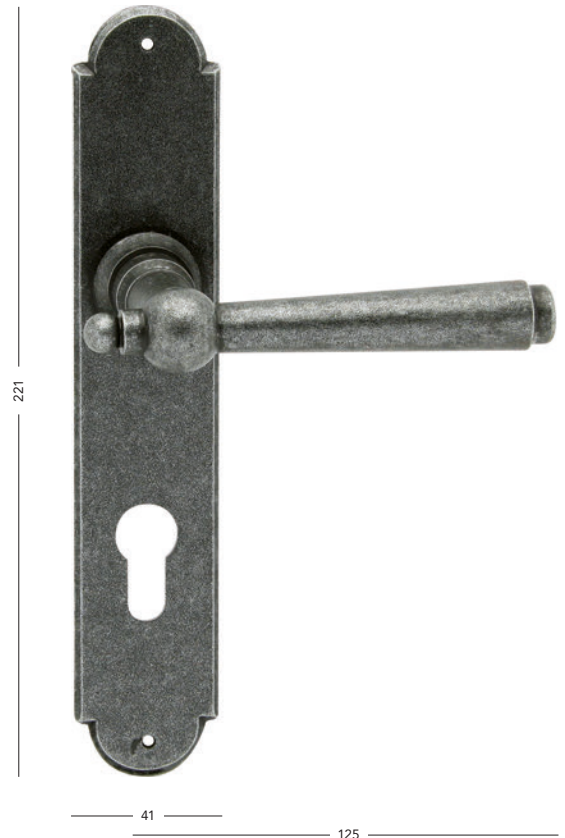

Dortmund

BB/PZ	67,20	80,60
PZ-LI/RE	75,20	90,20

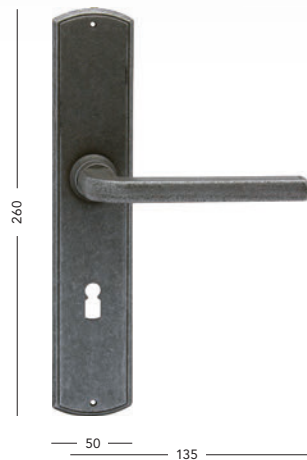

Hamburg-R

BB/PZ	63,20	75,80
WC	71,20	85,40



125



52

Hamburg-R+

PZ	102,00	122,40
----	--------	--------



125



60

Imst+

PZ	115,60	138,70
PZ-LI/RE	115,60	138,70



250



55

130

Imst-R

BB/PZ	35,20	42,20
PZ-LI/RE	59,20	71,00

72



130

Manheim

BB/PZ	82,20	98,60
PZ-LI/RE	66,30	79,60

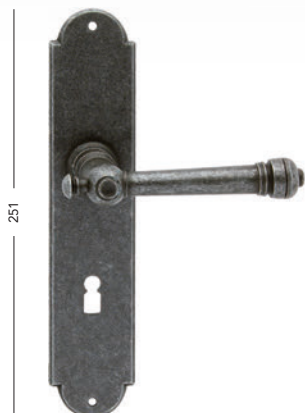

251

51

140



30

Regen



PZ L/R	111,60	133,90
K PZ-LI/RE	119,60	143,50
K PZ-LI/RE vyos.	119,60	143,50

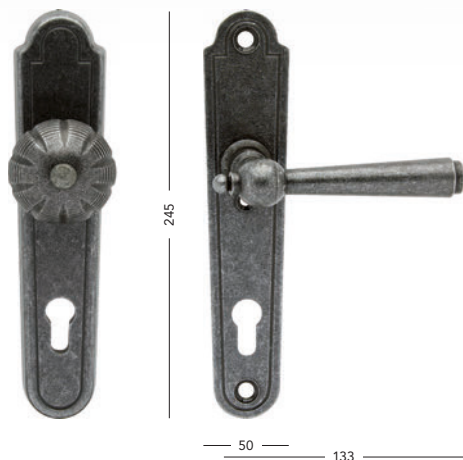

Wolfburg

BB/PZ	76,20	91,40
PZ-LI/RE	76,20	91,40

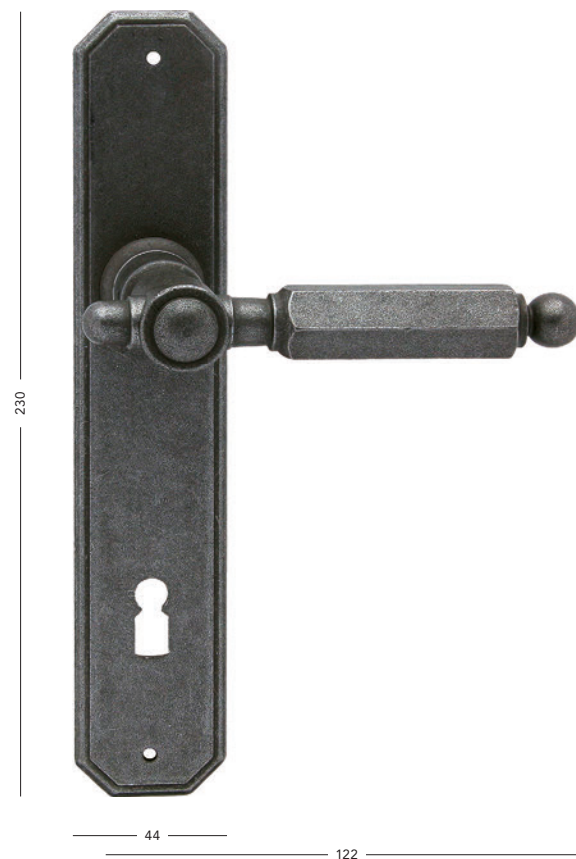

Okenné kovania

Oliva Hamburg

obj. číslo	HA235033
cena	39,60 47,50

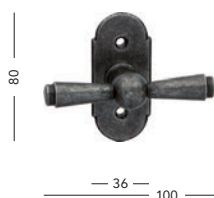

Pololiva velká Hamburg

obj. číslo	HA235106
cena	35,60 42,70



Oliva Manheim

obj. číslo	HA235038
cena	39,60 47,50

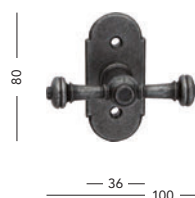

Pololiva velká Manheim

obj. číslo	HA235111
cena	35,60 42,70

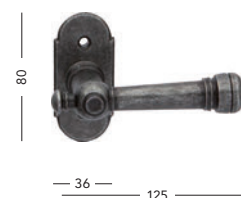

42

Bronz česaný

43	Alt-Wien	46	Swing
43	Atlantis	47	Swing-R
43	Dea	47	Venezia
43	Dea-R	47	Alt-Wien
43	Donna-R	47	Alt-Wien+
44	Elegant	47	C101+
44	Florence	48	Sveva
44	Giusy-R	48	Sveva+
44	Ikarus	48	Titan
44	Kristina	48	Titan+
45	Kristina-R		
45	Laura	49	Gula
45	Laura-R	49	Victory
45	Milena	49	Vittoria
45	Münster	49	Okenné kovania
46	Mystic-R	49	Alt-Wien
46	Rafaela-S	49	Elegant
46	Sina		
46	Sina-R		



Alt-Wien



BB/PZ	21,60	25,90
WC	27,60	33,10
PZ-LI/RE	29,60	35,50

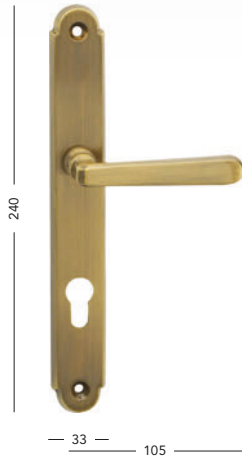

Atlantis



BB/PZ	31,60	37,90
WC	35,60	42,70
PZ-LI/RE	37,60	45,10

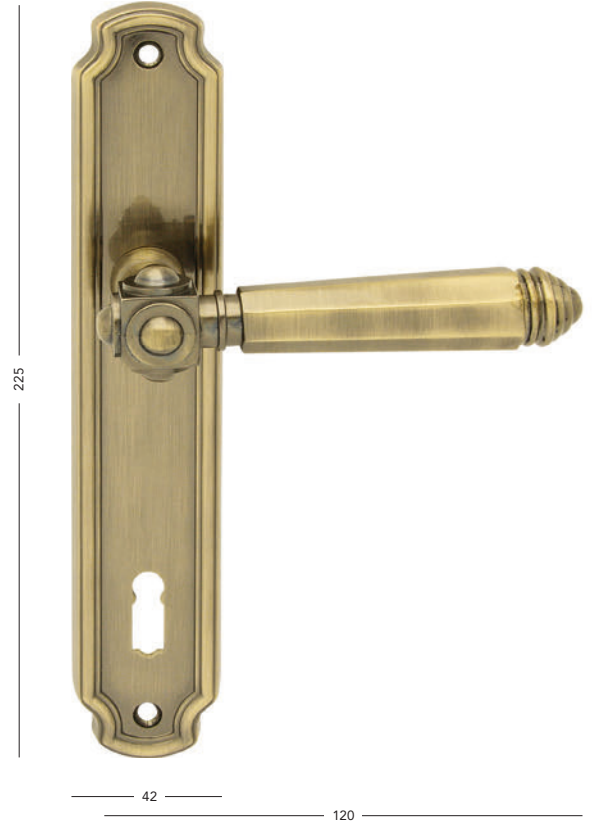

Dea



BB/PZ	23,60	28,30
WC	27,60	33,10
PZ-LI/RE	29,60	35,50

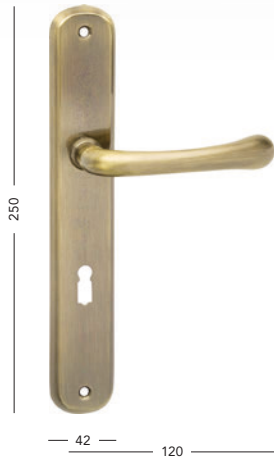

Dea-R



BB/PZ	25,60	30,70
WC	29,60	35,50
PZ-LI/RE	31,60	37,90



Donna-R



BB/PZ	15,40	18,50
WC	19,40	23,30
PZ-LI/RE	21,40	25,70



Elegant



BB/PZ	17,60	21,10
WC	21,60	25,90
PZ-LI/RE	23,60	28,30

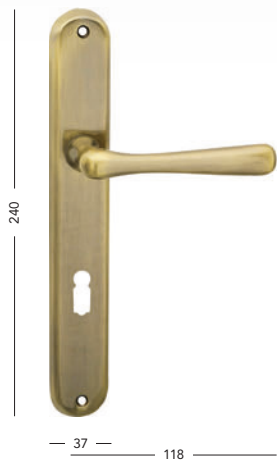

Florence



BB/PZ	31,20	37,40
WC	35,20	42,20
PZ-LI/RE	37,20	44,60

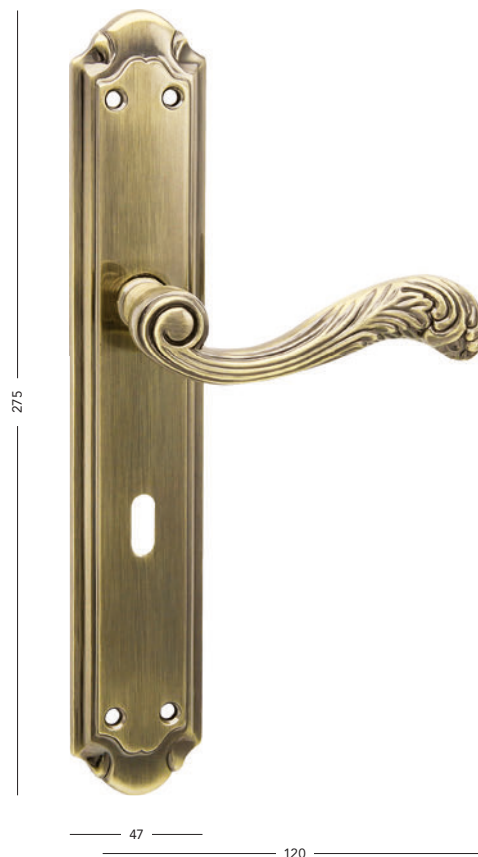

Gussy-R



BB/PZ	23,20	27,80
WC	27,20	32,60
PZ-LI/RE	29,20	35,00



Ikarus



BB/PZ	19,20	23,00
WC	23,20	27,80
PZ-LI/RE	25,20	30,20

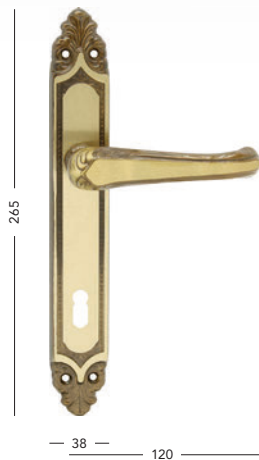

Kristina



BB/PZ	16,80	20,20
WC	20,80	25,00
PZ-LI/RE	22,80	27,40



Kristina-R



BB/PZ	19,20	23,00
WC	23,20	27,80
PZ-LI/RE	25,20	30,20



110



52

Laura



BB/PZ	14,80	17,80
WC	18,80	22,60
PZ-LI/RE	20,80	25,00

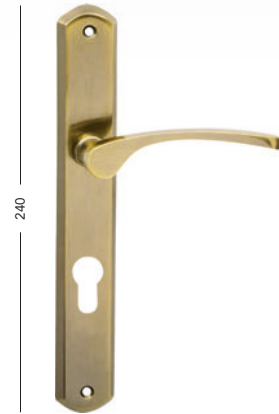

240

35

115

Laura-R



BB/PZ	17,60	21,10
WC	21,60	25,90
PZ-LI/RE	23,60	28,30



115



52

Münster



BB/PZ	13,20	15,80
WC	17,20	20,60
PZ-LI/RE	19,20	23,00



210

45

110

Milena



BB/PZ	13,60	16,30
WC	17,60	21,10
PZ-LI/RE	19,60	23,50



240

40

112

Mystic-R

BB/PZ	27,60	33,10
WC	31,60	37,90



112



55

Sina

BB/PZ	19,20	23,00
WC	23,20	27,80
PZ-LI/RE	25,20	30,20



240

40 117

Rafaela-S

BB/PZ	29,20	35,00
WC	33,20	39,80
PZ-LI/RE	35,20	42,20

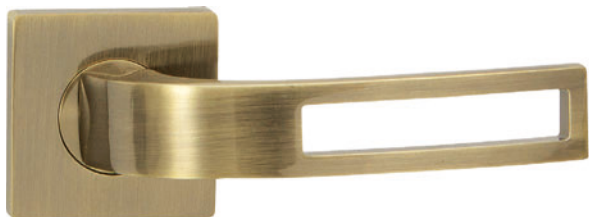

115



55

Sina-R

BB/PZ	25,20	30,20
WC	29,20	35,00
PZ-LI/RE	31,20	37,40



117



52

Swing

BB/PZ	19,20	23,00
WC	23,20	27,80
PZ-LI/RE	25,20	30,20

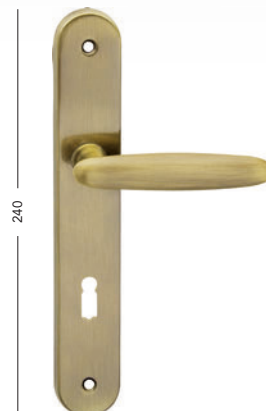

240

40 112

Swing-R



BB/PZ	19,20	23,00
WC	23,20	27,80
PZ-LI/RE	25,20	30,20



112



52

Venezia



BB/PZ	19,20	23,00
WC	23,20	27,80
PZ-LI/RE	25,20	30,20



225

45

125

Alt-Wien



PZ L/R	79,20	95,00
KPZ-LI/RE	79,20	95,00



280



40

120

Alt-Wien+



PZ L/R	99,60	119,50
KPZ-LI/RE	99,60	119,50



280



40

120

C101+



K PZ-LI/RE	25,20	30,20
------------	-------	-------



245



50

122

Sveva



PZ L/R	47,60	57,10
K PZ-LI/RE	47,60	57,10



Titan



PZ L/R	47,60	57,10
K PZ-LI/RE	47,60	57,10



Sveva+



PZ L/R	75,60	90,70
K PZ LI/RE	75,60	90,70



Titan+



PZ L/R	75,60	90,70
K PZ LI/RE	75,60	90,70



Guľa pevná

Victory

obj. číslo C415918602
cena ks 15,40 18,50



Guľa otočná

Vittoria 8 mm

obj. číslo FB25918X00
cena pár 44,10 52,90

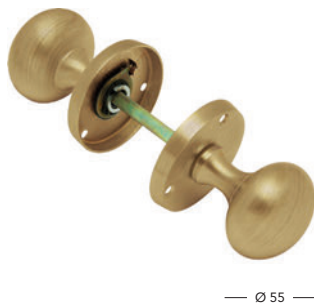

Na vyžiadanie samostatná guľa bez rozety alebo guľa otočná.

Okenné kovania Alt-Wien

Oliva

obj. číslo P06458X60B
cena 12,00 14,40

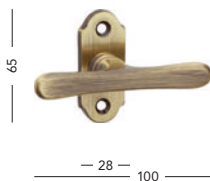

Pololiva

obj. číslo P06448X00B
cena 10,80 13,00

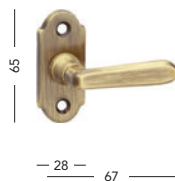

Pololiva veľká

obj. číslo P06468X00N
cena 12,40 14,90

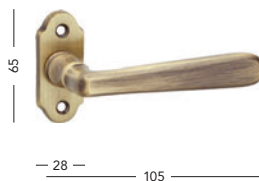

Balkónová kľučka

obj. číslo P06478X00B
cena 15,60 18,70

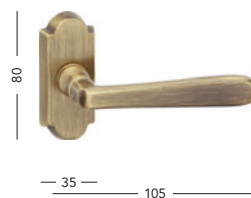

Rozvora

obj. číslo P06438X00B
cena 14,80 17,80

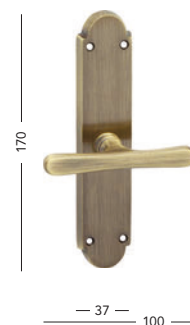

Okenné kovania Elegant

Oliva

obj. číslo P01028X00B
cena 10,00 12,00

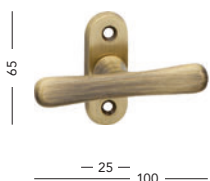

Pololiva

obj. číslo P01048X00B
cena 9,20 11,00

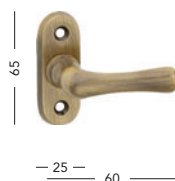

Pololiva veľká

obj. číslo P01068X00B
cena 11,60 13,90



Balkónová kľučka

obj. číslo P01058X00B
cena 13,20 15,80

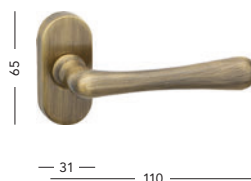

Rozvora

obj. číslo P01038X00B
cena 12,40 14,90

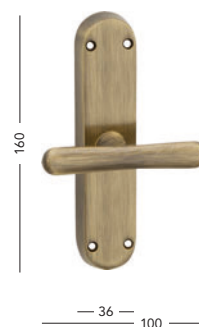

50

Mosadz leštěná

51 Alt-Wien
51 Atlantis
51 Elegant
51 Ikarus
52 Kristina
52 Kristina-R
52 Laura
52 Laura-R
53 Münster
53 Quadra-R
53 Alt-Wien
53 Alt-Wien+
53 Sveva
54 Sveva+
54 Titan
54 Titan+

54 Gula
54 Victory
54 Sfera
54 Georgian
55 Diamante
55 Vittoria
55 Okenné kovania
55 Alt-Wien
55 Elegant



Alt-Wien



BB/PZ	21,60	25,90
WC	27,60	33,10
PZ-LI/RE	29,60	35,50



Atlantis



BB/PZ	31,60	37,90
WC	35,60	42,70
PZ-LI/RE	37,60	45,10

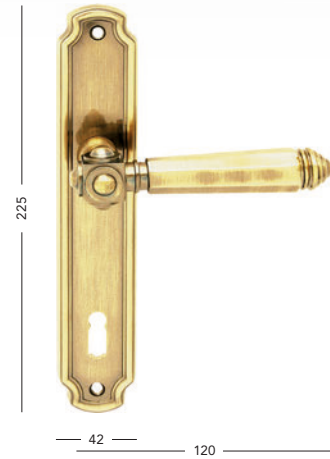

Elegant



BB/PZ	17,60	21,10
WC	21,60	25,90
PZ-LI/RE	23,60	28,30



Ikarus



BB/PZ	19,20	23,00
WC	23,20	27,80
PZ-LI/RE	25,20	30,20

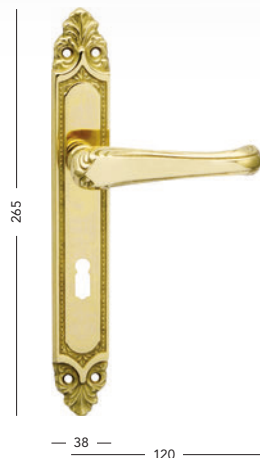

Kristina

BB/PZ	16,80	20,20
WC	20,80	25,00
PZ-LI/RE	22,80	27,40

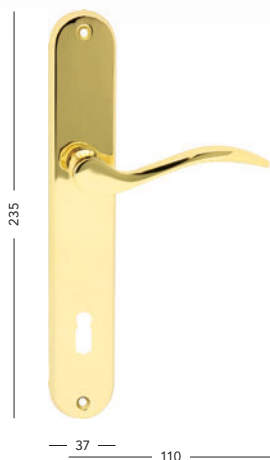
**Kristina-R**

BB/PZ	19,20	23,00
WC	23,20	27,80
PZ-LI/RE	25,20	30,20

**Laura**

BB/PZ	14,80	17,80
WC	18,80	22,60
PZ-LI/RE	20,80	25,00

**Laura-R**

BB/PZ	17,60	21,10
WC	21,60	25,90
PZ-LI/RE	23,60	28,30



Münster



BB/PZ	13,20	15,80
WC	17,20	20,60
PZ-LI/RE	19,20	23,00



Quadra-R



BB/PZ	102,00	122,40
WC	114,00	136,80
PZ-LI/RE	114,00	136,80

BUK, HRUŠKA, WENGE

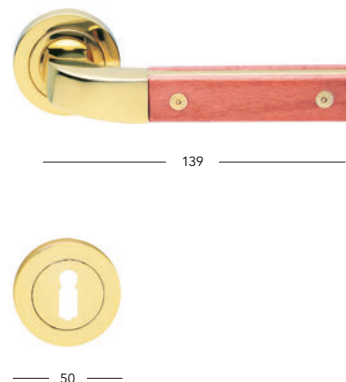

Alt-Wien



PZ L/R	79,20	95,00
KPZ-LI/RE	79,20	95,00



Alt-Wien+



PZ L/R	99,60	119,50
KPZ-LI/RE	99,60	119,50



Sveva



PZ L/R	47,60	57,10
KPZ-LI/RE	47,60	57,10



Sveva+



PZ L/R	75,60	90,70
K PZ-LI/RE	75,60	90,70



Titan



PZ L/R	47,60	57,10
K PZ-LI/RE	47,60	57,10



Titan+



PZ L/R	75,60	90,70
K PZ-LI/RE	75,60	90,70



Guľa pevná



Victory

obj. číslo	C415912602
cena ks	15,40 18,50

Sfera na závit 8 mm

obj. číslo	FB031212X00
cena	27,00 32,40

Georgian na závit 8 mm

obj. číslo	FB031012X00
cena ks	27,00 32,40

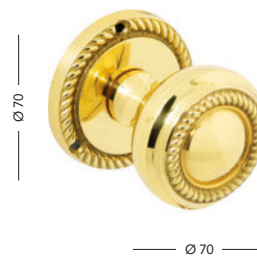
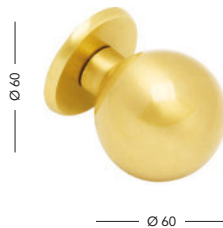
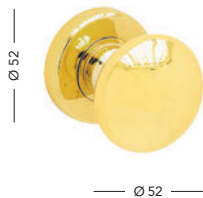

Na vyžiadanie samostatná guľa bez rozety alebo guľa otočná.

Gulá otočná

Diamante 8 mm

obj. číslo FB042012X00
cena pár 63,60 76,30

Diamante pevná 8 mm

obj. číslo FB042002X00
cena kus 31,60 37,90

Sfera 8 mm

obj. číslo FB031202X00
cena pár 54,00 64,80

Vittoria 8 mm

obj. číslo FB25912X00
cena pár 43,60 52,30



— Ø 60 —



— Ø 60 —



— Ø 55 —

Okenné kovania Alt-Wien

Oliva

obj. číslo P06452X00B
cena 12,00 14,40

Pololiva

obj. číslo P06442X00B
cena 10,80 13,00

Pololiva veľká

obj. číslo P06462X00B
cena 12,40 14,90

Balkónová kľučka

obj. číslo P06472X00B
cena 15,60 18,70

Rozvora

obj. číslo P06432X00B
cena 14,80 17,80



65
— 28 — 100 —

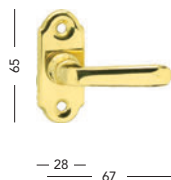

65
— 28 — 67 —

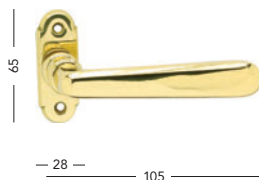

65
— 28 — 105 —

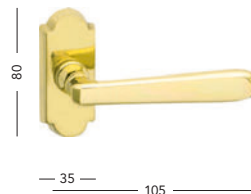

80
— 35 — 105 —

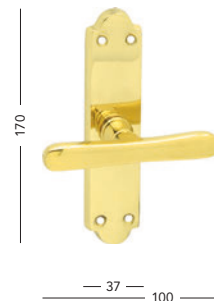

170
— 37 — 100 —

Okenné kovania Elegant

Oliva

obj. číslo P01022X00B
cena 10,00 12,00

Pololiva

obj. číslo P01042X00B
cena 9,20 11,00

Pololiva veľká

obj. číslo P01062X00N
cena 11,60 13,90

Balkónová kľučka

obj. číslo P01052X00B
cena 13,20 15,80

Rozvora

obj. číslo P01032X00B
cena 12,40 14,90



65
— 25 — 100 —

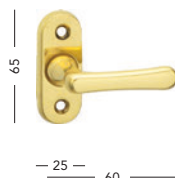

65
— 25 — 60 —

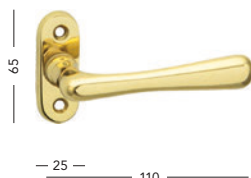

65
— 25 — 110 —

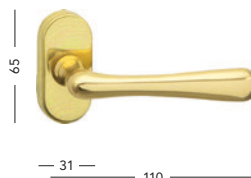

65
— 31 — 110 —

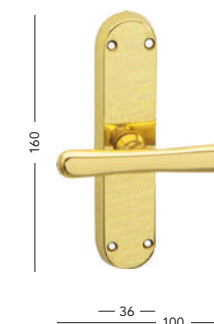

160
— 36 — 100 —

56

Staromosadz

57 Alt-Wien
57 Elegant

57 Okenné kovania
57 Alt-Wien
57 Elegant



Alt-Wien



BB/PZ	21,60	25,90
WC	27,60	33,10
PZ-LI/RE	29,60	35,50

Elegant



BB/PZ	19,60	23,50
WC	23,60	28,30
PZ-LI/RE	25,60	30,70

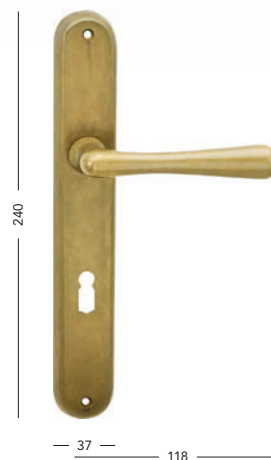
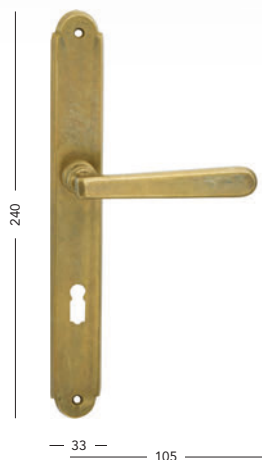

Okenné kovania Alt-Wien

Oliva

obj. číslo	P01024X00N
cena	12,80 15,40

Pololiva

obj. číslo	P01044X00N
cena	11,60 13,90

Pololiva veľká

obj. číslo	P01064X00N
cena	13,20 15,80

Balkónová kľučka

obj. číslo	P01054X00N
cena	16,40 19,70

Rozvora

obj. číslo	P01034X00N
cena	15,60 18,70

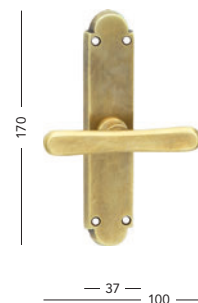
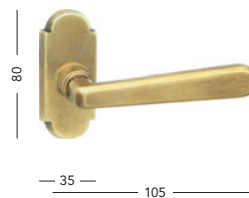
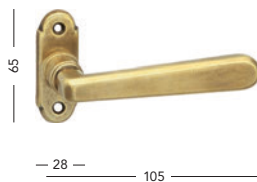
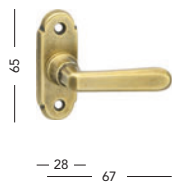
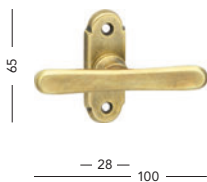

Okenné kovania Elegant

Oliva

obj. číslo	P06454X60N
cena	10,80 13,00

Pololiva

obj. číslo	P06444X00N
cena	10,00 12,00

Pololiva veľká

obj. číslo	P06464X00N
cena	12,40 14,90

Balkónová kľučka

obj. číslo	P06474X00N
cena	14,00 16,80

Rozvora

obj. číslo	P06434X00N
cena	13,20 15,80

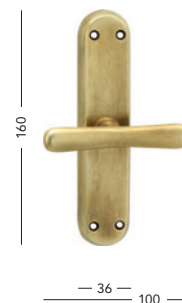
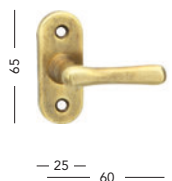
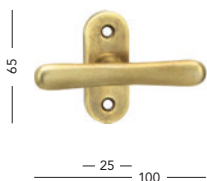

58

Strieborný elox

59	Element	62	R101+
59	Element-R	62	R111
59	Element-S	62	R111+
59	Flat	62	Slim 2
59	Flat-R	63	Tower
59	Flat-S	63	Tower+
60	Gussy		
60	Gussy-R	63	Rozety
60	Gussy-S	63	Rozeta Herold
60	Mira-R		
60	Monet	63	Okenné kovania
61	Monet-R	63	Univerzal
61	Plaza-R	63	Balkónová kľučka ST4
61	Plaza-S		
61	Universal		
61	Universal-R		
61	Herold		
62	Herold+		
62	R101		



Element



BB/PZ	9,00	10,80
WC	11,50	13,80
PZ-LI/RE	11,50	13,80

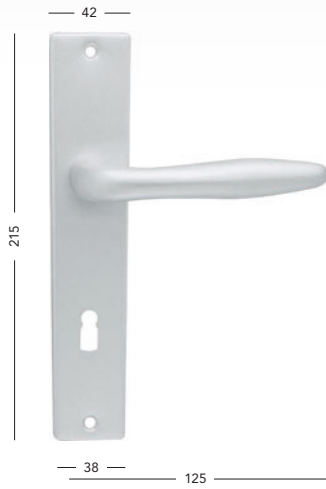

Element-R



BB/PZ	9,00	10,80
WC	11,50	13,80

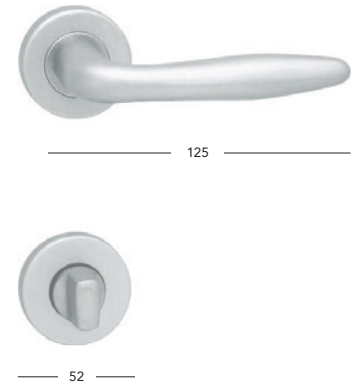

Element-S



BB/PZ	10,00	12,00
WC	12,50	15,00

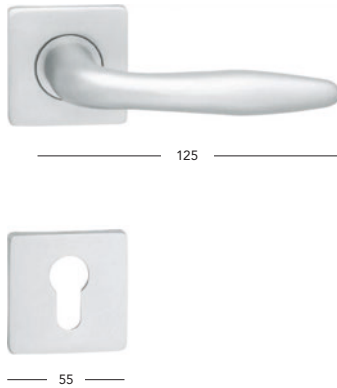

Flat



BB/PZ	9,00	10,80
WC	11,50	13,80
PZ-LI/RE	11,50	13,80



Flat-R



BB/PZ	9,00	10,80
WC	11,50	13,80

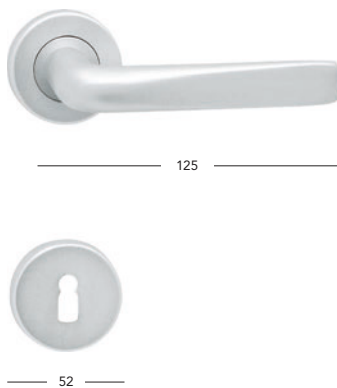

Flat-S



BB/PZ	10,00	12,00
WC	12,50	15,00

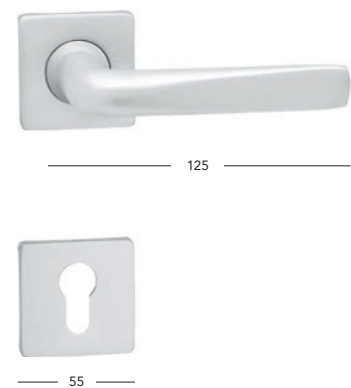

Giusy

BB/PZ	13,60	16,30
WC	15,60	18,70
PZ-LI/RE	15,60	18,70

**Giusy-R**

BB/PZ	13,60	16,30
WC	15,60	18,70



125

Giusy-S

BB/PZ	13,60	16,30
WC	15,60	18,70



125



52



55

Mira-R

BB/PZ	9,00	10,80
WC	11,50	13,80



125



50

Monet

BB/PZ	6,00	7,20
WC	9,60	11,50
PZ-LI/RE	10,60	12,70

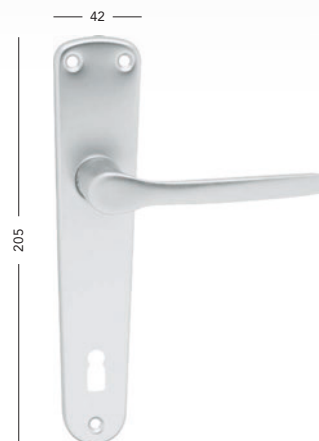

32

115

Monet-R

BB/PZ	6,00	7,20
WC	9,60	11,50
PZ-LI/RE	10,60	12,70



115



50

Plaza-R



BB/PZ	9,00	10,80
WC	11,50	13,80



117



52

Plaza-S



BB/PZ	10,00	12,00
WC	12,50	15,00



117



55

Universal

BB/PZ	6,00	7,20
WC	9,60	11,50
PZ-LI/RE	10,60	12,70

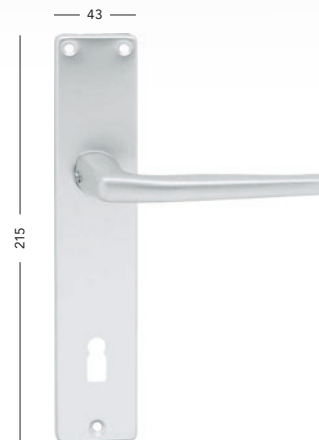

215

38

117

Universal-R

BB/PZ	6,00	7,20
WC	9,60	11,50
PZ-LI/RE	10,60	12,70



117



50

Herold



BB/PZ	31,60	37,90
PZ-LI/RE	31,60	37,90
dopredaj		

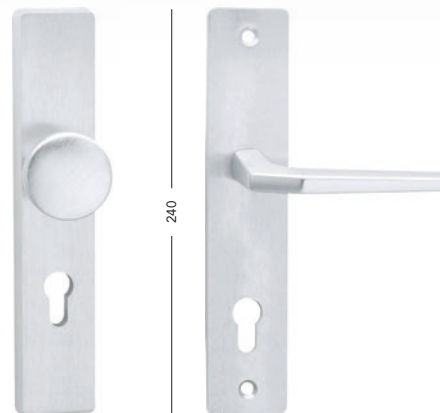

240

50

118

Herold+

BB/PZ 39,60 47,50
 PZ-LI/RE 39,60 47,50
 dopredaj

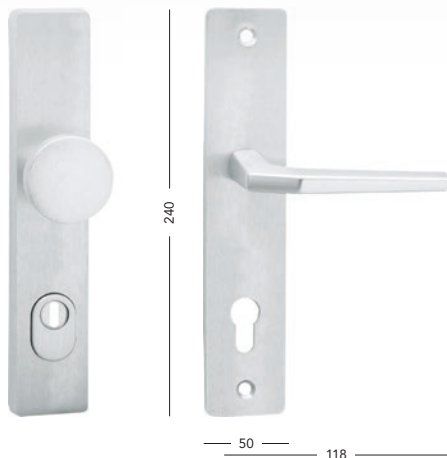
**R101**

PZ-LI/RE 37,60 45,10

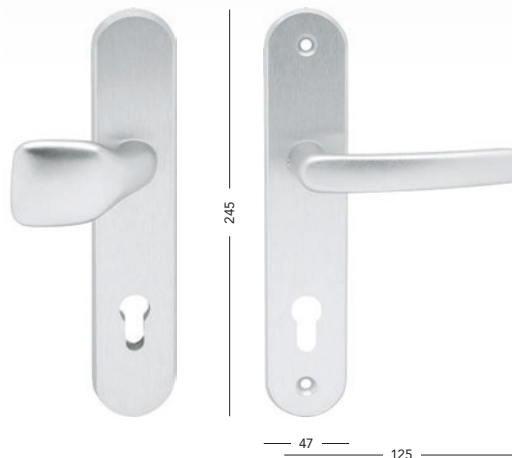
**R101+**

PZ-LI/RE 51,60 61,90

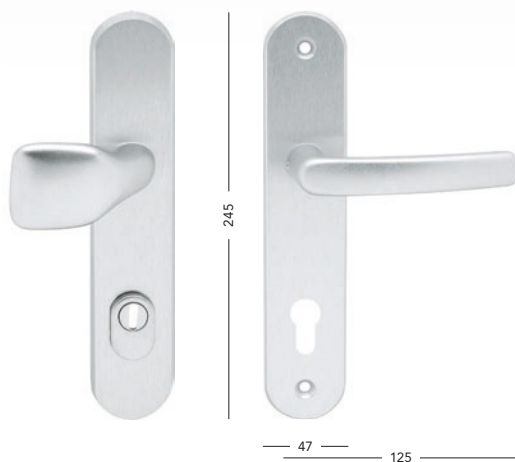
**R111**

PZ L/R 37,60 45,10

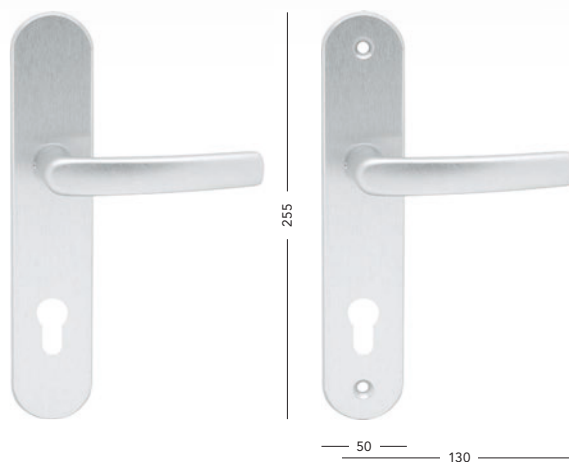
**R111+**

PZ L/R 51,60 61,90

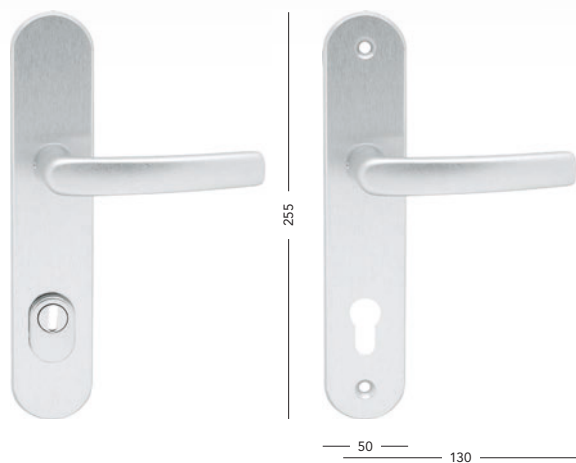
**Slim 2**

PZ L/R 19,20 23,00
 PZ-LI/RE 20,80 25,00



Tower



PZ L/R 33,60 40,30
PZ-LI/RE 33,60 40,30



Tower+



PZ L/R 47,60 57,10
PZ-LI/RE 47,60 57,10

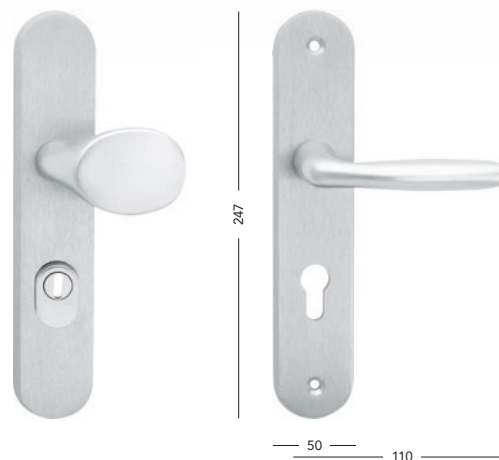

Rozeta Herold

PZ 22,00 26,40
dopredaj

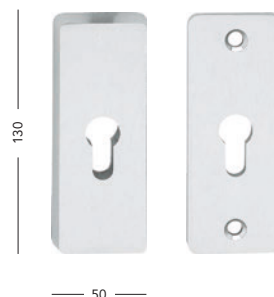

Okenné kovania

Oliva

obj. číslo C093F1OL
cena 3,80 4,60



Pololiva

obj. číslo C093F1PU
cena 3,80 4,60

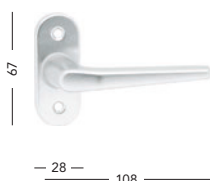

Rozvora

obj. číslo C093F1RO
cena 7,80 9,40



Balkónová kľučka ST4

obj. číslo COST4F1
cena 5,00 6,00

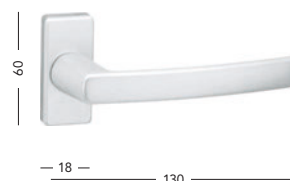

64

Nerezový elox

65	Element
65	Element-R
65	Element-S
65	Flat
65	Flat-R
66	Flat-S
66	Gussy
66	Gussy-R
66	Gussy-S
67	Laura Economy
67	Plaza-R
67	Plaza-S
67	R101
67	R101+
68	R111
68	R111+
68	Slim 2
68	Tower
69	Tower+



Element



BB/PZ	9,00	10,80
WC	11,50	13,80
PZ-LI/RE	11,50	13,80

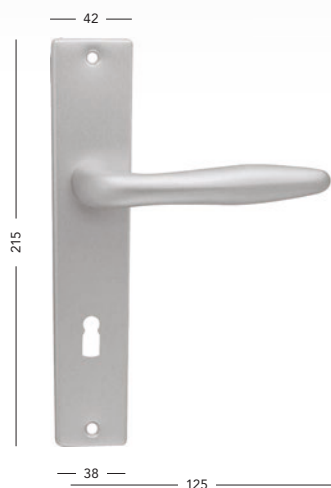

Element-R



BB/PZ	9,00	10,80
WC	11,50	13,80

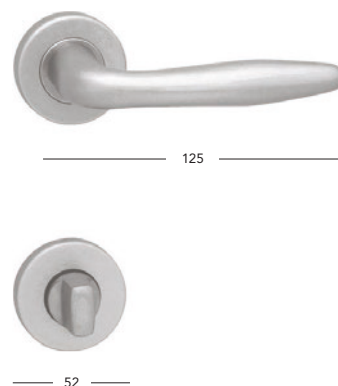

Element-S



BB/PZ	10,00	12,00
WC	12,50	15,00

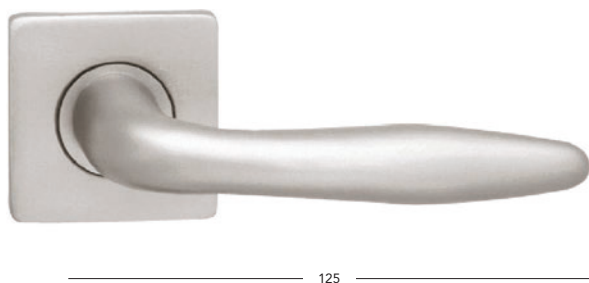

Flat



BB/PZ	9,00	10,80
WC	11,50	13,80
PZ-LI/RE	11,50	13,80



Flat-R



BB/PZ	9,00	10,80
WC	11,50	13,80

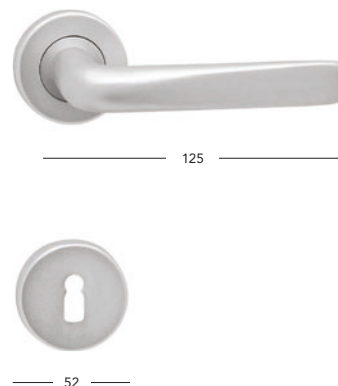

Flat-S

BB/PZ	10,00	12,00
WC	12,50	15,00



125



55

Giusy-S

BB/PZ	13,60	16,30
WC	15,60	18,70



125



55

Giusy

BB/PZ	13,60	16,30
WC	15,60	18,70
PZ-LI/RE	15,60	18,70

**Giusy-R**

BB/PZ	13,60	16,30
WC	15,60	18,70
PZ-LI/RE	15,60	18,70



125



52

Laura economy

BB/PZ 5,60 6,70

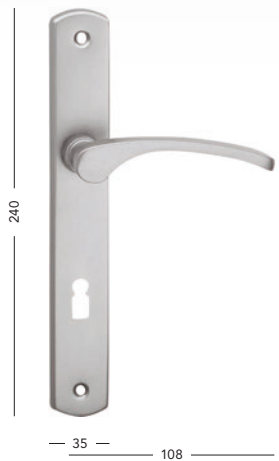

Plaza-R



BB/PZ 9,00 10,80
WC 11,50 13,80



Plaza-S



BB/PZ 10,00 12,00
WC 12,50 15,00

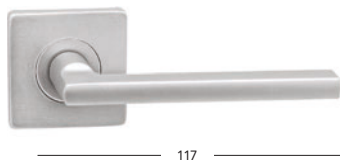

R101



PZ-LI/RE 39,60 47,50

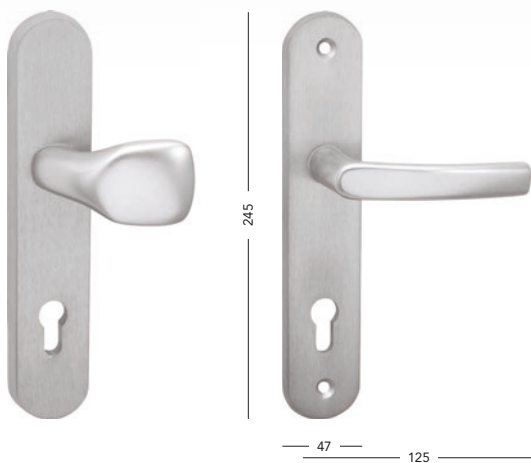

R101+



PZ-LI/RE 51,60 61,90

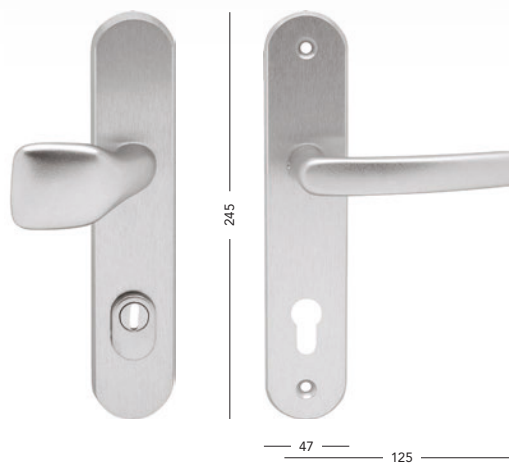

R111

PZ L/R 39,60 47,50

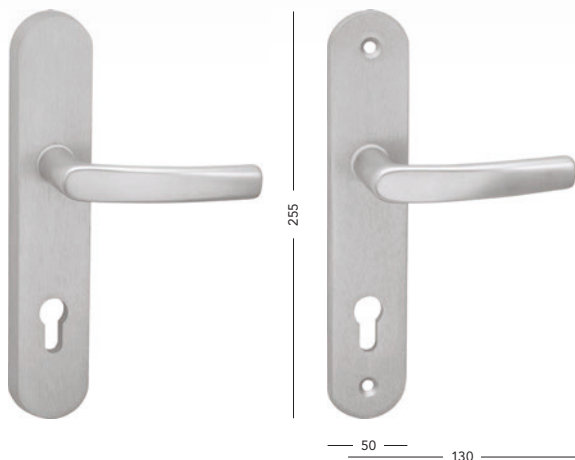
**Tower**PZ L/R 37,20 44,60
PZ-LI/RE 37,20 44,60**R111+**

PZ L/R 51,60 61,90

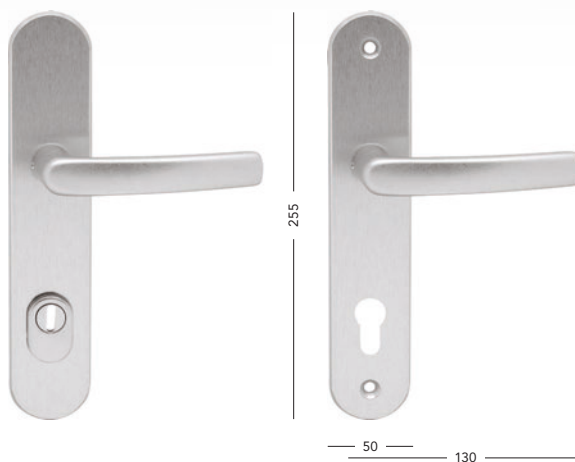
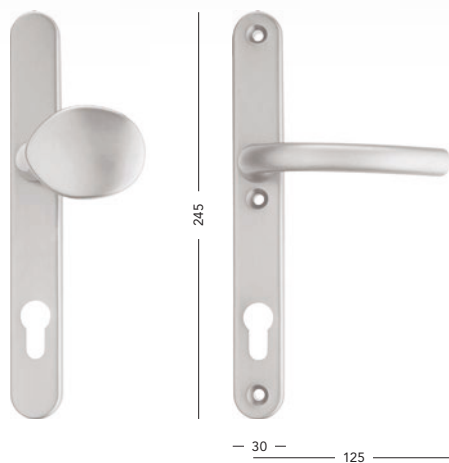
**Slim 2**PZ L/R 20,80 25,00
PZ-LI/RE 22,00 26,40

Tower+



PZ L/R	51,20	61,40
PZ-LI/RE	51,20	61,40



70

Bronzový elox

71	Element	74	R111+
71	Element-R	74	Slim 2
71	Element-S	75	Tower
71	Flat	75	Tower+
71	Flat-R		
72	Flat-S	74	Rozety
72	Giusy	74	Rozeta Herold
72	Giusy-R		
72	Giusy-S	75	Okenné kovania
72	Mira-R	75	Univerzal
73	Monet	75	Balkónová kľučka ST3
73	Monet-R		
73	Universal		
73	Universal-R		
73	Herold		
73	Herold+		
74	R101		
74	R101+		
74	R111		



Element



BB/PZ	9,00	10,80
WC	11,50	13,80
PZ-LI/RE	11,50	13,80

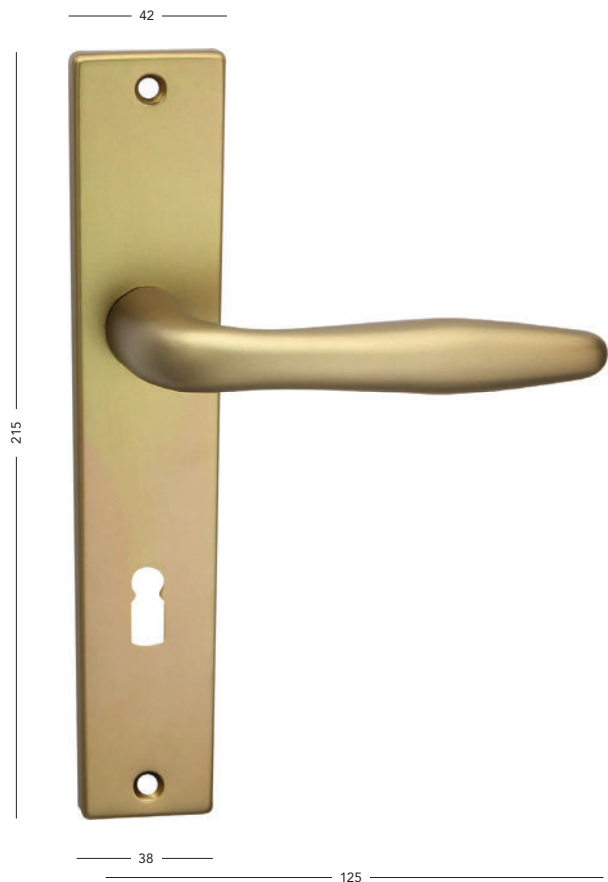

Element-R



BB/PZ	9,00	10,80
WC	11,50	13,80



Element-S



BB/PZ	10,00	12,00
WC	12,50	15,00



Flat



BB/PZ	9,00	10,80
WC	11,50	13,80
PZ-LI/RE	11,50	13,80

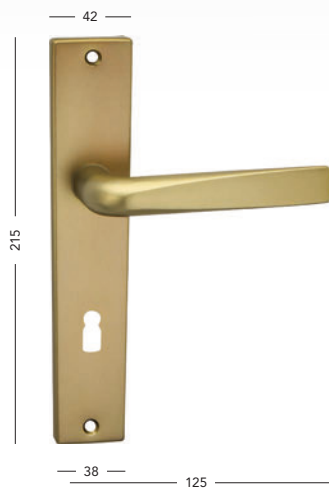

Flat-R



BB/PZ	9,00	10,80
WC	11,50	13,80



Flat-S



BB/PZ	10,00	12,00
WC	12,50	15,00



125



55

Gussy



BB/PZ	13,60	16,30
WC	15,60	18,70
PZ-LI/RE	15,60	18,70



42

215

38

125

Gussy-R



BB/PZ	13,60	16,30
WC	15,60	18,70



125



52

Mira-R

BB/PZ	9,00	10,80
WC	11,50	13,80



125

Gussy-S



BB/PZ	13,60	16,30
WC	15,60	18,70



125



55



50

Monet

BB/PZ	6,00	7,20
WC	9,60	11,50
PZ-LI/RE	10,60	12,70

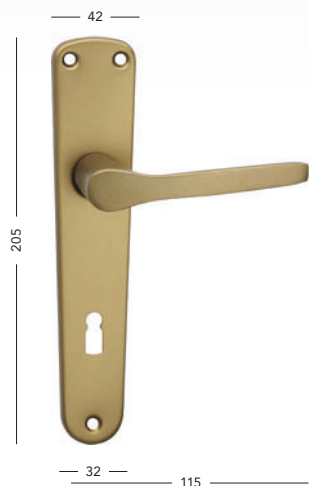

Monet-R

BB/PZ	6,00	7,20
WC	9,60	11,50
PZ-LI/RE	10,60	12,70



Universal

BB/PZ	6,00	7,20
WC	9,60	11,50
PZ-LI/RE	10,60	12,70



Universal-R

BB/PZ	6,00	7,20
WC	9,60	11,50
PZ-LI/RE	10,60	12,70



Herold



BB/PZ	31,60	37,90
PZ-LI/RE	31,60	37,90
dopredaj		

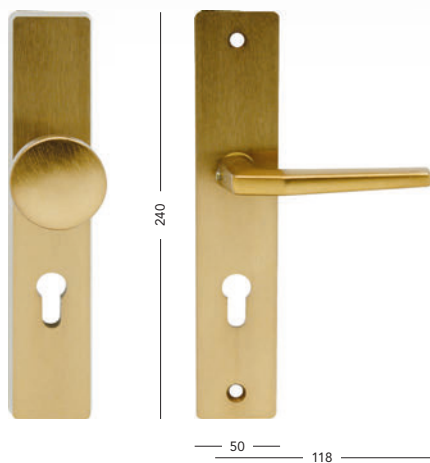

Herold+



BB/PZ	39,60	47,50
PZ-LI/RE	39,60	47,50
dopredaj		



R101

PZ-LI/RE 37,60 45,10

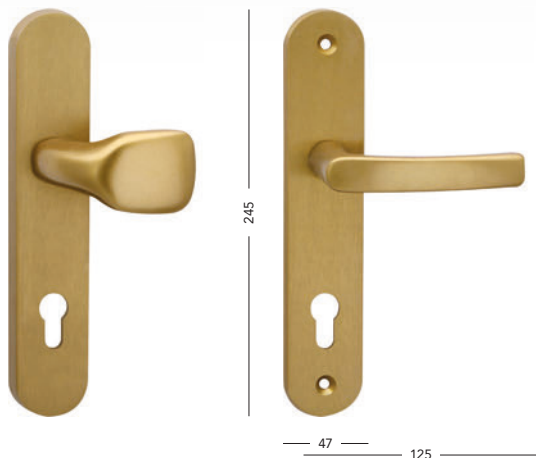
**R101+**

PZ-LI/RE 51,60 61,90

**R111**

PZ L/R 37,60 45,10

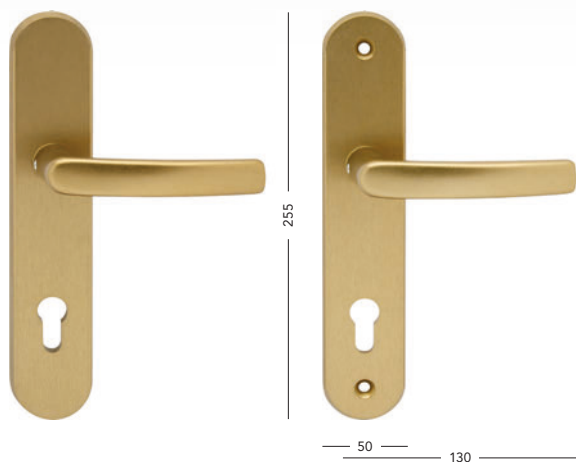
**R111+**

PZ L/R 51,60 61,90

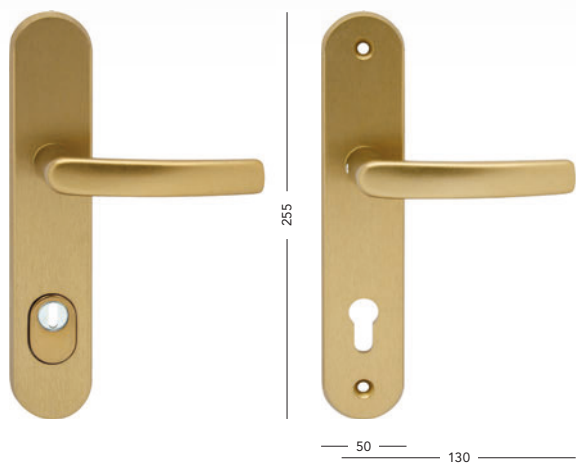
**Slim 2**PZ L/R 19,20 23,00
PZ-LI/RE 20,80 25,00

Tower



PZ L/R 33,60 40,30
PZ-LI/RE 33,60 40,30



Tower+



PZ L/R 47,60 57,10
PZ-LI/RE 47,60 57,10

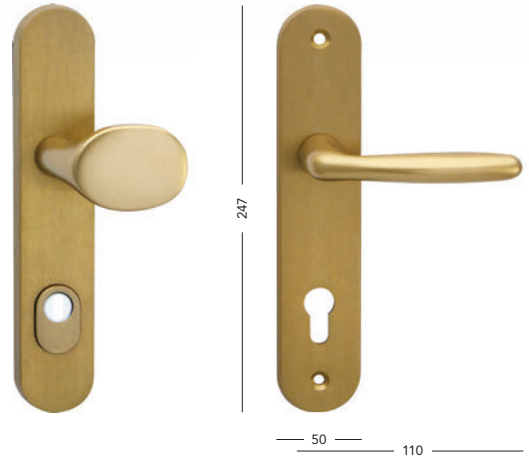

Rozeta Herold

PZ 22,00 26,40
dopredaj

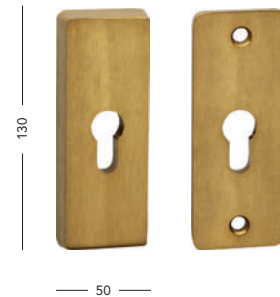

Okenné kovania

Oliva

obj. číslo C093F4OL
cena 3,80 4,60

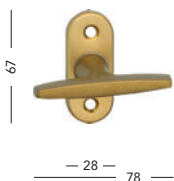

Pololiva

obj. číslo C093F4PU
cena 3,80 4,60

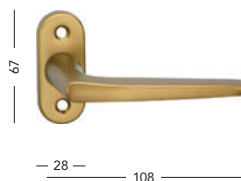

Rozvora

obj. číslo C093F4RO
cena 7,80 9,40

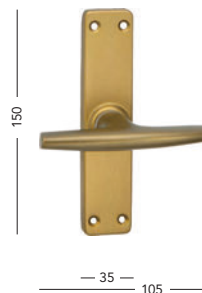

Balkónová kľučka ST3

obj. číslo C0ST3F4
cena 5,00 6,00

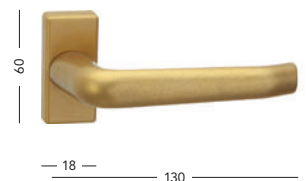

76

Biela
Zlatá
Sivá
Economy

77 Laura biela
77 Laura zlatá
77 Laura sivá
77 Michaela biela
77 Michaela zlatá
77 Michaela sivá



Laura biela

BB/PZ 4,00 4,80



Michaela biela

BB/PZ 4,00 4,80

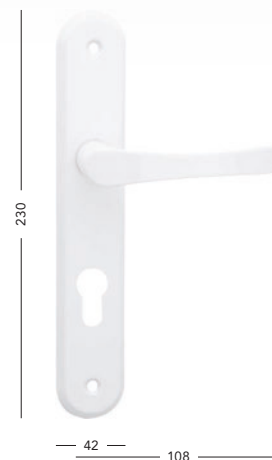

Laura zlatá

BB/PZ 4,00 4,80

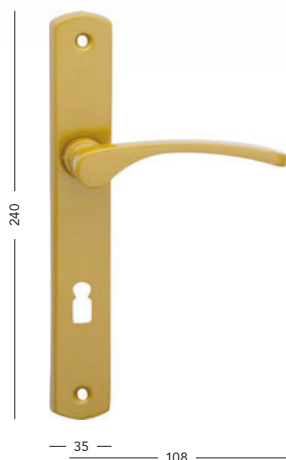

Michaela zlatá

BB/PZ 4,00 4,80

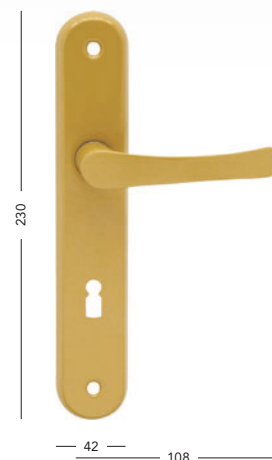

Laura sivá

BB/PZ 4,00 4,80

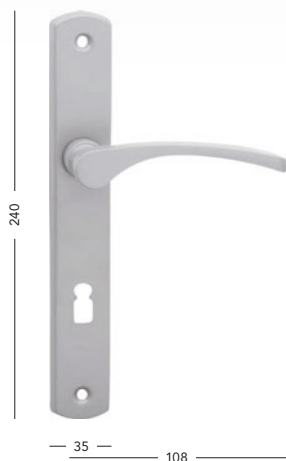

Michaela sivá

BB/PZ 4,00 4,80

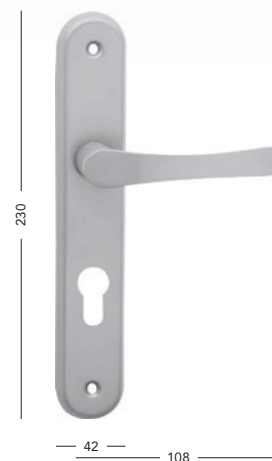

Rozety

5 3

Povrch	typ prevedenia	cena	Povrch	typ prevedenia	cena	Povrch	typ prevedenia	cena
IN	BB/PZ	6,00 7,20	ONS	BB/PZ	6,00 7,20	IN	BB/PZ economy	6,00 7,20
IN	WC set	13,40 16,10	ONS	WC set	13,40 16,10	IN	WC set economy	13,40 16,10
IN	Ovál BB/PZ	6,00 7,20	OCN	BB/PZ	6,00 7,20			
IN	Ovál WC	13,40 16,10	OCN	WC set	13,40 16,10			
OCS	BB/PZ	6,00 7,20	OFS	BB/PZ	6,00 7,20			
OCS	WC set	13,40 16,10	OFS	WC set	13,40 16,10			
OC	BB/PZ	6,00 7,20	OLV	BB/PZ	6,00 7,20			
OC	WC set	13,40 16,10	OLV	WC set	13,40 16,10			

*Záruka 3 roky na povrch OCS,
cena za kus (WC cena za pár)
*Záruka 5 rokov na povrch IN,
cena za kus (WC cena za pár)



Sortiment rozetového kovania na masívne základni ponúkame na skrutkovacích rozetách.

Sortiment rozetového kovania Economy ponúkame na narážacích rozetách pre jednoduchú a rýchlu montáž.

Balkónová kľučka



Název	cena
Element	13,30 15,90
Gabri	18,00 21,60
Mega	15,00 18,00
Nathalia	20,10 24,10
Orion	11,10 13,40
Swing	10,70 12,80

Povrch	typ prevedenia	cena
BIELA	ST1	4,80 5,80
HNEDÁ	ST1	4,80 5,80
ZLATÁ	ST1	4,80 5,80

„Informujte sa u vášho predajcu na možnosť zloženia balkónovej kľučky podľa vášho výberu.“

Úchytky

Povrch	typ prevedenia	obj. číslo	cena
IN	Hranatá bez otvoru	C1592EX03	7,20 8,60
IN	Hranatá BB	C1591EX03	7,20 8,60
OCS	Ovál bez otvoru	P15909X03P	7,70 9,20
OC	Ovál bez otvoru	P15905X03P	7,70 9,20
ONS	Ovál bez otvoru	P15906X03P	7,70 9,20
OFS	Ovál bez otvoru	P15907X03P	7,70 9,20
OLV	Ovál bez otvoru	P15902X03P	7,70 9,20
OCS	Ovál BB	P15909X13P	7,70 9,20
OC	Ovál BB	P15905X13P	7,70 9,20
ONS	Ovál BB	P15906X13P	7,70 9,20
OFS	Ovál BB	P15907X13P	7,70 9,20
OLV	Ovál BB	P15902X13P	7,70 9,20
OCS	Ovál WC vnútorné	P15909X331P	11,10 13,30
OCS	Ovál WC vonkajšie	P15909X332P	11,10 13,30
OC	Ovál WC vnútorné	P15905X331P	11,10 13,30
OC	Ovál WC vonkajšie	P15905X332P	11,10 13,30
ONS	Ovál WC vnútorné	P15906X331P	11,10 13,30
ONS	Ovál WC vonkajšie	P15906X332P	11,10 13,30
OFS	Ovál WC vnútorné	P15907X331P	11,10 13,30
OFS	Ovál WC vonkajšie	P15907X332P	11,10 13,30
OLV	Ovál WC vnútorné	P15902X331P	11,10 13,30
OLV	Ovál WC vonkajšie	P15902X332P	11,10 13,30

Hranatá bez otvoru



Ovál bez otvoru

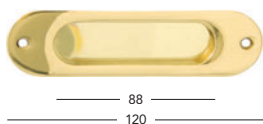

Ovál WC vnútorné

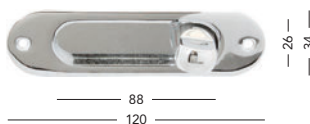

Ovál BB

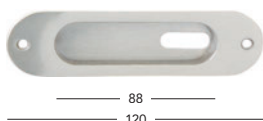

Ovál WC vonkajšie



Hĺbka 12 mm

Madla

Povrch	typ prevedenia	obj. číslo kus	cena	obj. číslo pár	cena
IN	INOX A	CHMADLOA	47,20 56,60	CHMADLOAP	72,80 87,40
IN	INOX B	CHMADLOB	34,60 41,50	CHMADLOBP	53,30 63,90
IN	INOX C	CHMADLOC	30,20 36,30	CHMADLOCP	46,60 55,90
IN	INOX D	CHMADLOD	38,90 46,70	CHMADLODP	60,00 72,00
IN	INOX E	CHMADLOE	43,70 52,40	CHMADLOEP	60,40 72,50
IN	INOX F	CHMADLOF	43,70 52,40	CHMADLOFP	60,40 72,50

Povrch	typ prevedenia	obj. číslo kus	cena	obj. číslo pár	cena
IN	INOX G 600	CHMADLOJ	40,30 48,40	CHMADLOJP	26,40 67,70
IN	INOX G 700	CHMADLOG	42,80 51,40	CHMADLOGP	62,00 74,40
IN	INOX G 800	CHMADLOH	48,30 57,90	CHMADLOHP	70,00 84,00
IN	INOX G 1000	CHMADLOI	44,90 53,90	CHMADLOIP	74,90 89,90

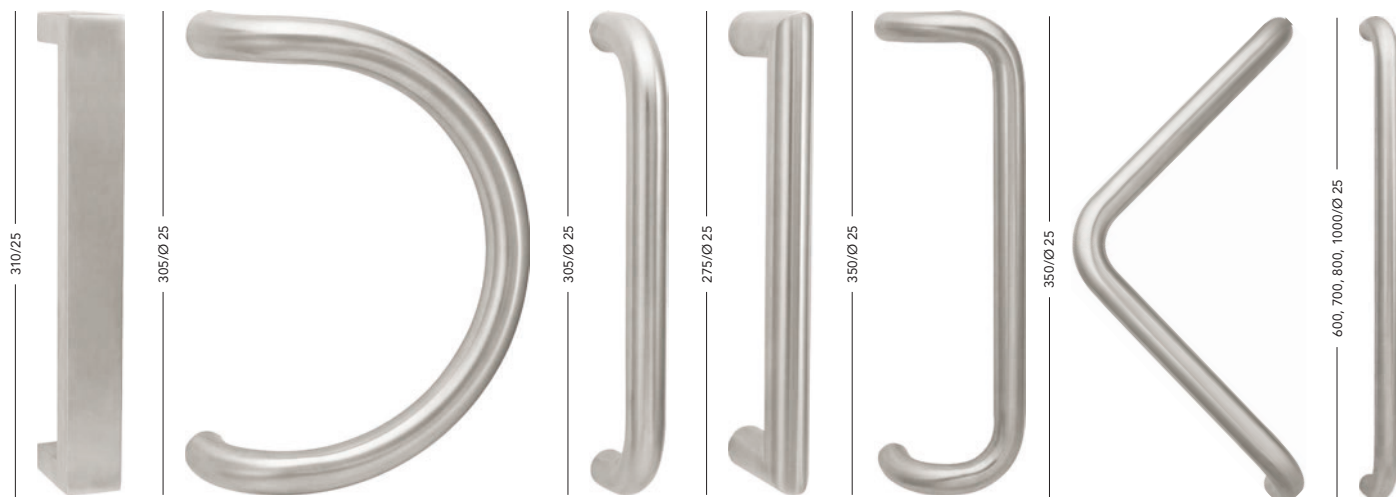

Úchyty

Úchyt posuvné dvere A

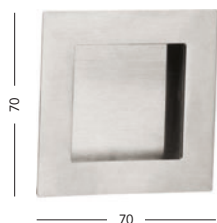

Úchyt posuvné dvere B

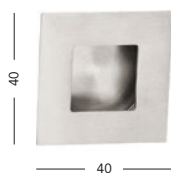

Úchyt posuvné dvere C



Úchyt posuvné dvere D

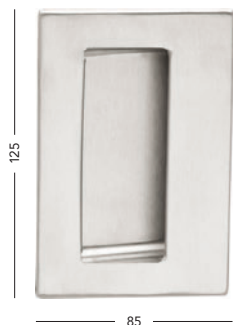

Úchyt posuvné dvere E



Povrch	typ prevedenia	obj. číslo	cena
IN	Úchyt pos. dvere A	C160EXA	7,60 9,10
IN	Úchyt pos. dvere B	C160EXB	4,80 5,80
IN	Úchyt pos. dvere C	C160EXC	5,20 6,20
IN	Úchyt pos. dvere D	C160EXD	11,60 13,90
IN	Úchyt pos. dvere E	C160EXE	4,80 5,80

Úchytky kované



Povrch	typ prevedenia	obj. číslo	cena
K	Ovál 001	HA217001	11,60 13,90
K	Ovál 003	HA217003	14,10 16,90
K	Ovál 004	HA217004	14,10 16,90

Úchytky sklenená výplň



Povrch	typ prevedenia	obj. číslo	cena
IN	J8341-S krátky	CSJ8341-S	9,80 11,80
IN	J8343	CSJ8343	12,00 14,40

Vložky cylindrické

Povrch	typ prevedenia	obj. číslo	cena	Povrch	typ prevedenia	obj. číslo	cena
ONS	EURO 30/35	RIV30356EURO	5,20	ONS	EURO Secure 30/35	RIV30356EUROSEC	12,80
OFS	EURO 30/35	RIV30356EURO	5,20	ONS	Winkhaus 30/35	WRPE01N3035	79,20
OS	EURO 30/35	RIV30356EURO	5,20				95,00

EURO 30/35



EURO SECURE 30/35



WINKHAUS 30/35



Zámky zadlabavacie

Posuvné dvere BB

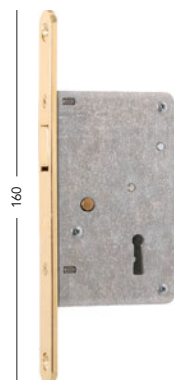

Posuvné dvere PZ

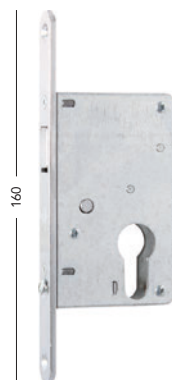

Posuvné dvere WC

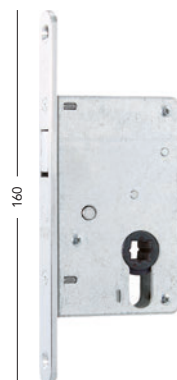

BB

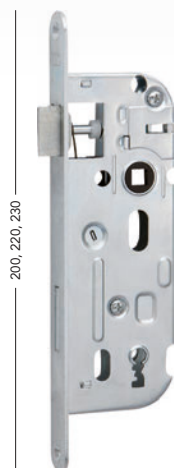

PZ

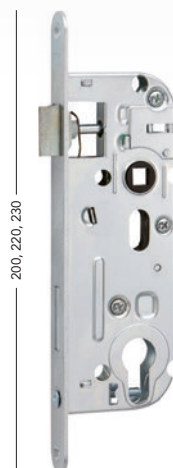

WC



Trojbodový



Povrch	typ prevedenia	obj. číslo	cena	Povrch	typ prevedenia	obj. číslo	cena
OC	BB 60/160	P16009X10A	19,60	POZINK	BB 72/60/200	21120740	7,70
OC	BB 70/160	P16009X10B	19,60	POZINK	BB 72/80/220	21120640	9,80
OC	BB 60/160	P16005X10A	19,60	POZINK	BB 90/60/230	21120840	7,70
OC	BB 70/160	P16005X10B	19,60	POZINK	BB 90/80/230	21120540	8,10
OLV	BB 60/160	P16001X10A	19,60	POZINK	PZ 72/60/200	21120750	8,10
OLV	BB 70/160	P16001X10B	19,60	POZINK	PZ 72/80/220	21120650	10,30
OC	PZ 60/160	P16209X20A	19,60	POZINK	PZ 90/60/230	21120850	8,10
OC	PZ 70/160	P16209X20B	19,60	POZINK	PZ 90/80/230	21120550	7,70
OC	PZ 60/160	P16205X20A	19,60	POZINK	PZ 90/80/230	21120550	7,70
OC	PZ 70/160	P16205X20B	19,60	POZINK	WC 72/60/200	21120760	9,00
OLV	PZ 60/160	P16201X20A	19,60	POZINK	WC 72/80/220	21120660	9,40
OLV	PZ 70/160	P16201X20B	19,60	POZINK	WC 90/60/230	21120860	10,30
OC	WC 60/160	P16109X30A	19,60	POZINK	WC 90/80/230	21120560	11,60
OC	WC 70/160	P16109X30B	19,60				
OC	WC 60/160	P16105X30A	19,60	Povrch	typ prevedenia	obj. číslo	cena
OC	WC 70/160	P16105X30B	19,60	POZINK	Protiplech + kapsy	CZP0016P	0,90
OLV	WC 60/160	P16101X30A	19,60	ŽL. POZ.	Protiplech + kapsy	CZP0012P	0,90
OLV	WC 70/160	P16101X30B	19,60				
OLV	WC 60/160	P16101X30A	19,60	Povrch	typ prevedenia	obj. číslo	cena
OLV	WC 70/160	P16101X30B	19,60	ŽL. POZ.	PZ 90/60/200/2040	211209731	85,60

Protiplech



200

2040

WC set na posuvné dvere

Povrch	typ prevedenia	obj. číslo	cena
OCS	WC set kulatý	A5700930	39,20 47,00
OFS	WC set kulatý	A5700830	39,20 47,00
OCS	WC set hranatý	A5700H930	35,20 42,20

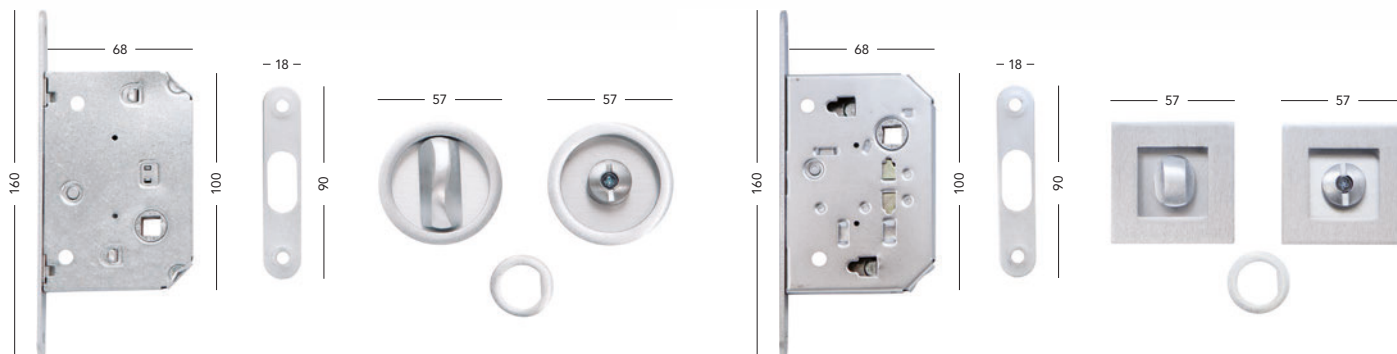

Záklopka dverí



Povrch	typ prevedenia	obj. číslo	cena	
POBR	Záklopka 160 mm	LC260160B002	2,60	3,10
POBR	Záklopka 200 mm	LC260200B002	2,80	3,40
POBR	Záklopka 250 mm	LC260250B002	3,00	3,60
POBR	Záklopka 300 mm	LC260300B002	3,00	3,60
POBR	Záklopka 400 mm	LC260400B002	3,20	3,80
POBR	Záklopka 500 mm	LC260500B002	4,00	4,80
POBR	Záklopka 600 mm	LC260600B002	6,40	7,70
POBR	Záklopka 800 mm	LC260800B002	11,20	13,40
POZINK	Záklopka 160 mm	LC260160H002	2,20	2,60
ŽL. POZ.	Záklopka 160 mm	LC260160H102	2,20	2,60
ŽL. POZ.	Záklopka 200 mm	LC260200H102	2,40	2,90
ŽL. POZ.	Záklopka 250 mm	LC260250H102	2,80	3,40
ŽL. POZ.	Záklopka 300 mm	LC260300H102	2,80	3,40
ŽL. POZ.	Záklopka 400 mm	LC260400H102	3,00	3,60
POMOS	Záklopka 500 mm	LC260500O002	3,60	4,30
POMOS	Záklopka 600 mm	LC260600O002	5,60	6,70
POMOS	Záklopka 800 mm	LC260800O002	9,00	10,80

Záves kyvných dverí

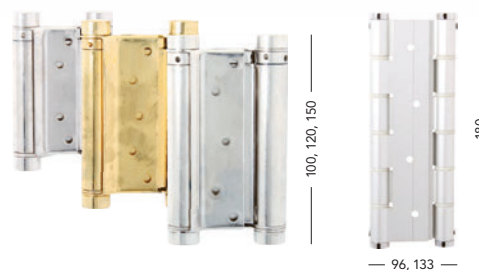

Povrch	typ prevedenia	obj. číslo	cena	
OF	Záves 100 mm	21179020P	17,20	20,60
OLV	Záves 100 mm	21179000P	21,20	25,40
PONIKL	Záves 100 mm	21179010P	17,20	20,60
OF	Záves 125 mm	21179120P	22,40	26,90
OLV	Záves 125 mm	21179100P	22,40	26,90
PONIKL	Záves 125 mm	21179110P	22,40	26,90
OF	Záves 150 mm	21179220P	30,80	37,00
OLV	Záves 150 mm	21179200P	30,80	37,00
PONIKL	Záves 150 mm	21179210P	30,80	37,00

Povrch	typ prevedenia	obj. číslo	cena	
F1	Záves 180x96 mm	7J5904F1	54,80	65,70
F4	Záves 180x96 mm	7J5904F4	57,40	68,80
F1	Záves 180x133 mm	7J5914F1	50,90	61,10
F4	Záves 180x133 mm	7J5914F4	53,10	63,70
BIELA	Záves 180x133 mm	7J5914PX	53,10	63,70

Skrytý pant

do 50 kg

do 35 kg

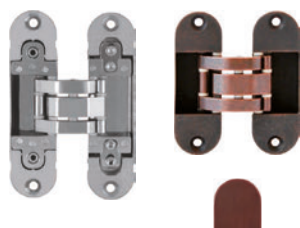

Povrch	typ prevedenia	obj. číslo	cena	
ONS	Nastavitelný do 50kg	IN300120VN02	27,30	32,70
PONIKL	Nastavitelný do 50kg	IN300120H004	24,30	29,10
POZINK	Nastavitelný do 50kg	IN300120V702	27,30	32,70
POBR	Nastavitelný do 50kg	IN300120B002	28,50	34,20
BIELA	Nastavitelný do 50kg	IN300120P02	27,30	32,70
ONS	Pevný do 35kg	IN301090V702	13,50	16,20
POBR	Pevný do 35kg	IN301090B002	14,40	17,30
ONS	Krytka sk. pant 4 ks	GC300010J202	1,20	1,40
POZINK	Krytka sk. pant 4 ks	GC300010J102	1,20	1,40
POBR	Krytka sk. pant 4 ks	GC3000109R02	1,20	1,40
BIELA	Krytka sk. pant 4 ks	GC3000109P02	1,20	1,40

Záves kovaný

H001

H002

H008

H011



Povrch	typ prevedenia	obj. číslo	cena	
K	Záves H001 23 cm dolný	HA129X001	44,60	53,50
K	Záves H002 14,5 cm dolný	HA129X002	35,50	42,60
K	Záves H008 32 cm horný	HA127X008	37,20	44,70
K	Záves H011 42 cm horný	HA127X011	39,40	47,30
K	Záves H025 39 cm horný	HA127X025	46,00	55,20
K	Záves H027 60 cm horný	HA127X027	44,10	52,90

H025

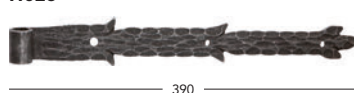

H027



Záves 030



Povrch	typ prevedenia	obj. číslo	cena
POMOS	Záves 030 13 mm horný	CF030130O006	0,20 0,30
POMOS	Záves 030 13 mm dolný	CG030130O004	0,30 0,40
ŽL. POZ.	Záves 030 13 mm horný	CF030130H128	0,20 0,30
ŽL. POZ.	Záves 030 13 mm dolný	CG030130H126	0,20 0,30
POZINK	Záves 030 13 mm horný	CF030130H021	0,20 0,30
POZINK	Záves 030 13 mm dolný	CG030130H023	0,30 0,30

Povrch	typ prevedenia	obj. číslo	cena
POMOS	Záves 030 14 mm horný	CF030140O002	0,50 0,60
POMOS	Záves 030 14 mm dolný	CG030140O002	0,60 0,80
ŽL. POZ.	Záves 030 14 mm horný	CF030140H116	0,20 0,30
ŽL. POZ.	Záves 030 14 mm dolný	CG030140H118	0,30 0,30
BRONZ	Záves 030 14 mm horný	CF030140B102	0,90 1,10
BRONZ	Záves 030 14 mm dolný	CG030140B102	1,00 1,20
ŽL. POZ.	Záves 030 16 mm horný	CF030160H151	0,30 0,30
ŽL. POZ.	Záves 030 16 mm dolný	CG030160H161	0,30 0,40

Záves 055



Povrch	typ prevedenia	obj. číslo	cena
POMOS	Záves 055 13 mm horný	CF055130O008	0,30 0,30
POMOS	Záves 055 13 mm dolný	CG055130O010	0,30 0,40
ŽL. POZ.	Záves 055 13 mm horný	CF055130H131	0,20 0,30
ŽL. POZ.	Záves 055 13 mm dolný	CG055130H131	0,20 0,30
POBR	Záves 055 13 mm horný	CF055130B013	0,30 0,30
POBR	Záves 055 13 mm dolný	CG055130B013	0,30 0,40
ONS	Záves 055 13 mm horný	CF055130N402	0,80 0,90
ONS	Záves 055 13 mm dolný	CG055130N402	0,60 0,70
PONIKL	Záves 055 13 mm horný	CF055130N005	0,30 0,40
PONIKL	Záves 055 13 mm dolný	CG055130N005	0,30 0,40
POMOS	Záves 055 14 mm horný	CF055140O007	0,30 0,40
POMOS	Záves 055 14 mm dolný	CG055140O005	0,30 0,40
ŽL. POZ.	Záves 055 14 mm horný	CF055140H119	0,20 0,30

Povrch	typ prevedenia	obj. číslo	cena
ŽL. POZ.	Záves 055 14 mm dolný	CG055140H127	0,30 0,40
POBR	Záves 055 14 mm horný	CF055140B011	0,30 0,30
POBR	Záves 055 14 mm dolný	CG055140B011	0,30 0,40
PONIKL	Záves 055 14 mm horný	CF055140N004	0,30 0,40
PONIKL	Záves 055 14 mm dolný	CG055140N008	0,30 0,40
POMOS	Záves 055 16 mm horný	CF055160O005	0,40 0,50
POMOS	Záves 055 16 mm dolný	CG055160O005	0,50 0,60
ŽL. POZ.	Záves 055 16 mm horný	CF055160H104	0,30 0,40
ŽL. POZ.	Záves 055 16 mm dolný	CG055160H106	0,40 0,50
POBR	Záves 055 16 mm horný	CF055160B004	0,40 0,50
POBR	Záves 055 16 mm dolný	CG055160B004	0,60 0,70
PONIKL	Záves 055 16 mm horný	CF055160N006	0,40 0,50
PONIKL	Záves 055 16 mm dolný	CG055160N006	0,50 0,60

Záves 100



Povrch	typ prevedenia	obj. číslo	cena
POMOS	Záves 100 15 mm horný	CF100150O004	0,60 0,70
POMOS	Záves 100 15 mm dolný	CG100150O013	0,60 0,80
BRONZ	Záves 100 15 mm horný	CF100150B105	1,60 1,90
BRONZ	Záves 100 15 mm dolný	CG100150B116	1,60 1,90
PONIKL	Záves 100 15 mm horný	CF100150N007	0,40 0,50
PONIKL	Záves 100 15 mm dolný	CG100150N026	0,60 0,70
POZINK	Záves 100 15 mm horný	CF100150H004	0,40 0,50
POZINK	Záves 100 15 mm dolný	CG100150H017	0,60 0,70
ONS	Záves 100 15 mm horný	CF100150N402	1,20 1,40
ONS	Záves 100 15 mm dolný	CG100150N406	2,00 2,40

Záves 180

Povrch	typ prevedenia	obj. číslo	cena
POMOS	Záves 180 16 mm horný	CF180160O004	1,00 1,20
POMOS	Záves 180 16 mm dolný	CG180160O004	1,10 1,30
BRONZ	Záves 180 16 mm horný	CF180160B104	1,30 1,50
BRONZ	Záves 180 16 mm dolný	CG180160B106	1,40 1,70



Záves 190

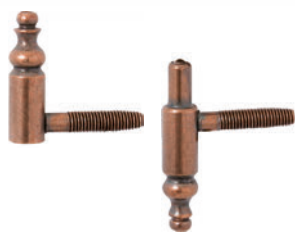

Povrch	typ prevedenia	obj. číslo	cena
POMOS	Záves 190 13 mm horný	CF190130O006	0,40 0,50
POMOS	Záves 190 13 mm dolný	CG190130O006	0,40 0,50
ŽL. POZ.	Záves 190 13 mm horný	CF190130H106	0,30 0,40
ŽL. POZ.	Záves 190 13 mm dolný	CG190130H108	0,40 0,50
POBR	Záves 190 13 mm horný	CF190130B006	0,40 0,50
POBR	Záves 190 13 mm dolný	CG190130B006	0,40 0,50
BRONZ	Záves 190 13 mm horný	CF190130B110	0,40 0,50
BRONZ	Záves 190 13 mm dolný	CG190130B112	0,50 0,60
POMOS	Záves 190 14 mm horný	CF190140O004	0,40 0,50
POMOS	Záves 190 14 mm dolný	CG190140O004	0,40 0,50
ŽL. POZ.	Záves 190 14 mm horný	CF190140H104	0,50 0,60

Povrch	typ prevedenia	obj. číslo	cena
ŽL. POZ.	Záves 190 14 mm dolný	CG190140H104	0,50 0,60
POBR	Záves 190 14 mm horný	CF190140B004	0,40 0,50
POBR	Záves 190 14 mm dolný	CG190140B004	0,50 0,60
POMOS	Záves 190 16 mm horný	CF190160O002	0,70 0,80
POMOS	Záves 190 16 mm dolný	CG190160O002	0,70 0,80
ŽL. POZ.	Záves 190 16 mm horný	CF190160H102	0,60 0,80
ŽL. POZ.	Záves 190 16 mm dolný	CG190160H102	0,60 0,70
POBR	Záves 190 16 mm horný	CF190160B004	0,60 0,80
POBR	Záves 190 16 mm dolný	CG190160B004	0,70 0,90
BRONZ	Záves 190 16 mm horný	CF190160B104	0,70 0,90
BRONZ	Záves 190 16 mm dolný	CG190160B104	0,80 1,00

Záves 220



Povrch	typ prevedenia	obj. číslo	cena
POMOS	Záves 220 15 mm horný	CF2211500O002	1,80 2,10
POMOS	Záves 220 15 mm dolný	CG2211500O003	2,00 2,40
BRONZ	Záves 220 15 mm horný	CF2211500B102	1,80 2,20
BRONZ	Záves 220 15 mm dolný	CG2211500B105	2,50 3,00
ONS	Záves 220 15 mm horný	CF2211500N402	3,00 3,60
ONS	Záves 220 15 mm dolný	CG2211500N403	4,20 5,10

Záves 300



Povrch	typ prevedenia	obj. číslo	cena
ŽL. POZ.	Záves 300 13 mm horný	CI300130H110	0,90 1,00
POBR	Záves 300 14 mm dolný	CI300140B004	1,10 1,30
ŽL. POZ.	Záves 300 14 mm horný	CI300140H112	1,00 1,20
POBR	Záves 300 16 mm dolný	CI300160B004	1,40 1,60
ŽL. POZ.	Záves 300 16 mm dolný	CI300160H104	1,30 1,50

Záves 320

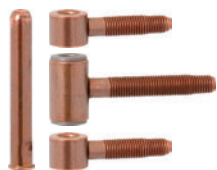

Povrch	typ prevedenia
POMOS	Záves 320 16 mm
ŽL. POZ.	Záves 320 16 mm
POBR	Záves 320 16 mm
POMOS	Záves 320 18 mm
ŽL. POZ.	Záves 320 18 mm
POBR	Záves 320 18 mm
POMOS	Záves 320 20 mm
ŽL. POZ.	Záves 320 20 mm
ŽL. POZ.	Záves 320 20 mm WAS
POBR	Záves 320 20 mm

obj. číslo	cena
CI320160O006	2,30 2,70
CI320160H114	1,60 1,90
CI320160B004	2,00 2,40
CI320180O006	2,50 3,00
CI320180H104	2,20 2,60
CI320180B004	2,40 2,90
CI320200O008	3,40 4,10
CI320200H114	2,80 3,40
CI320200H115	4,50 5,40
CI320200B008	3,20 3,90

Záves 330



Povrch	typ prevedenia
POMOS	Záves 330 16 mm
BRONZ	Záves 330 16 mm

obj. číslo	cena
CI330160O008	4,90 5,90
CI330160B106	4,90 5,90

Záves 488



Povrch	typ prevedenia	obj. číslo	cena
ŽL. POZ.	Záves 488 16 mm pravolevý	CI488160H104	17,00 20,40

Krytka ozdobná k závesu 495

Povrch	typ prevedenia
OLV	Krytka 16 mm
OLV	Krytka 18 mm
OLV	Krytka 22 mm
POBR	Krytka 16 mm
POBR	Krytka 18 mm
POBR	Krytka 22 mm

obj. číslo	cena
GC839160L103	4,00 4,80
GC839180L103	5,00 6,00
GC839220L103	9,40 11,30
GC839160B003	3,70 4,40
GC839180B003	4,00 4,80
GC839220B004	7,90 9,50



Záves 495



Povrch	typ prevedenia	obj. číslo	cena
ŽL. POZ.	Záves 495 14 mm horný	CF495140H119	2,50 3,00
ŽL. POZ.	Záves 495 14 mm dolný	CG495140H102	2,40 2,80
POZINK	Záves 495 14 mm horný	CF495140H519	1,60 1,90
POZINK	Záves 495 14 mm dolný	CG495140H502	2,60 3,10
ŽL. POZ.	Záves 495 16 mm horný	CF495160H102	2,10 2,50
ŽL. POZ.	Záves 495 16 mm dolný	CG495160H102	2,40 2,80
ŽL. POZ.	Záves 465 16 mm sp. WAS	CF495160H110	4,50 5,30
POZINK	Záves 495 16 mm horný	CF495160H502	2,20 2,60

Povrch	typ prevedenia	obj. číslo	cena
POZINK	Záves 495 16 mm dolný	CG495160H502	3,30 3,90
POZINK	Záves 465 16 mm sp. WAS	CF495160H504	4,50 5,30
ŽL. POZ.	Záves 495 20 mm horný	CF495200H104	3,40 4,10
ŽL. POZ.	Záves 495 20 mm dolný	CG495200H106	4,20 5,00
ŽL. POZ.	Záves 465 20 mm sp. WAS	CF495200H111	6,80 8,20
POZINK	Záves 495 20 mm horný	CF495200H502	3,00 3,70
POZINK	Záves 495 20 mm dolný	CG495200H502	4,20 5,00
POZINK	Záves 465 20 mm sp. WAS	CF495200H505	5,80 6,90

Návlek k závesu 495



Povrch	typ prevedenia	obj. číslo	cena
OLV	Krytka 16 mm	GC838160L103	3,00 3,60
OLV	Krytka 18 mm	GC838180L104	3,30 4,00
OLV	Krytka 22 mm	GC838220L104	4,50 5,40
POBR	Krytka 16 mm	GC838160B003	2,10 2,50
POBR	Krytka 18 mm	GC838180B004	4,60 5,50
POBR	Krytka 22 mm	GC838220B004	5,20 6,20
ZLATÁ	Krytka 16 mm plast	GC838150JO04	2,10 2,50
ZLATÁ	Krytka 18 mm plast	GC838170JO02	3,10 3,70
ZLATÁ	Krytka 22 mm plast	GC838210JO02	3,90 4,70
BIELA	Krytka 16 mm plast	GC838160Y301	0,70 0,90
BIELA	Krytka 18 mm plast	GC838180Y303	0,70 0,80

Povrch	typ prevedenia	obj. číslo	cena
BIELA	Krytka 22 mm plast	GC838220Y301	1,00 1,20
OC	Krytka 15 mm plast	GC838150JI02	1,30 1,50
OC	Krytka 18 mm plast	GC838180YB01	3,10 3,70
OC	Krytka 22 mm plast	GC838220Z404	2,90 3,50
ONS	Krytka 16 mm plast	GC838160YC01	4,00 4,80
ONS	Krytka 18 mm plast	GC838180YC01	5,20 6,20
ONS	Krytka 22 mm plast	GC838220YC01	6,10 7,30
F4	Krytka 16 mm plast	GC838150JZ02	2,50 3,00
F4	Krytka 18 mm plast	GC838170JZ02	2,60 3,10
F4	Krytka 22 mm plast	GC838210JZ02	3,30 3,90

Záves 530



Povrch	typ prevedenia	obj. číslo	cena
POMOS	Záves 530 9 mm horný	CF530090O004	0,20 0,20
POMOS	Záves 530 9 mm dolný	CG530090O006	0,20 0,30
ŽL. POZ.	Záves 530 9 mm horný	CF530090H102	0,10 0,20
ŽL. POZ.	Záves 530 9 mm dolný	CG530090H102	0,20 0,20
POBR	Záves 530 9 mm horný	CF530090B008	0,20 0,20
POBR	Záves 530 9 mm dolný	CG530090B014	0,20 0,30
POZINK	Záves 530 9 mm horný	CF530090H008	0,10 0,20
POZINK	Záves 530 9 mm dolný	CG530090H008	0,20 0,20
POMOS	Záves 530 11 mm horný	CF530110O002	0,20 0,30
POMOS	Záves 530 11 mm dolný	CG530110O002	0,20 0,30
ŽL. POZ.	Záves 530 11 mm horný	CF530110H104	0,20 0,30
ŽL. POZ.	Záves 530 11 mm dolný	CG530110H104	0,20 0,30
POZINK	Záves 530 11 mm horný	CF530110H006	0,20 0,20
POZINK	Záves 530 11 mm dolný	CG530110H004	0,20 0,30

Záves 605



Povrch	typ prevedenia	obj. číslo	cena
POMOS	Záves 605 9 mm horný	CF605090O006	0,20 0,30
POMOS	Záves 605 9 mm dolný	CG605090O008	0,30 0,30
POBR	Záves 605 9 mm horný	CF605090B008	0,20 0,30
POBR	Záves 605 9 mm dolný	CG605090B015	0,30 0,30
BRONZ	Záves 605 9 mm horný	CF605090B106	0,30 0,30
BRONZ	Záves 605 9 mm dolný	CG605090B108	0,30 0,40
POMOS	Záves 605 11 mm horný	CF605110O003	0,30 0,40
POMOS	Záves 605 11 mm dolný	CG605110O003	0,40 0,50
POBR	Záves 605 11 mm horný	CF605110B003	0,30 0,40
POBR	Záves 605 11 mm dolný	CG605110B003	0,40 0,50
BRONZ	Záves 605 11 mm horný	CF605110B105	0,30 0,40
BRONZ	Záves 605 11 mm dolný	CG605110B107	0,40 0,50

Stavač dverí



Povrch	typ prevedenia	obj. číslo	cena
OC	Stavač dverí 899	C8991310	3,40 4,10
BIELA	Stavač dverí 899	C8991320	3,40 4,10
OLV	Stavač dverí 899	C8991330	3,40 4,10
HNEDÁ	Stavač dverí 899	C8991340	3,40 4,10
ONS	Stavač dverí 899	C8991350	3,40 4,10



Povrch	typ prevedenia	obj. číslo	cena
OC	Stavač dverí 898S	C8981310	3,90 4,60
BIELA	Stavač dverí 898S	C8981310	3,90 4,60
OLV	Stavač dverí 898S	C8981310	3,90 4,60
HNEDÁ	Stavač dverí 898S	C8981310	3,90 4,60
ONS	Stavač dverí 898S	C8981310	3,90 4,60



Povrch	typ prevedenia	obj. číslo	cena
OC	Stavač dverí 898L	C8982810	4,20 5,10
BIELA	Stavač dverí 898L	C8982820	4,20 5,10
OLV	Stavač dverí 898L	C8982830	4,20 5,10
HNEDÁ	Stavač dverí 898L	C8982840	4,20 5,10
ONS	Stavač dverí 898L	C8982850	4,20 5,10

Zarážka dverí



Povrch	typ prevedenia	obj. číslo	cena
OCS	Zarážka dverí 1004	C10049X00	2,60 3,10
OC	Zarážka dverí 1004	C10045X00	2,60 3,10
ONS	Zarážka dverí 1004	C10046X00	2,60 3,10
OFS	Zarážka dverí 1004	C10048X00	2,60 3,10
OLV	Zarážka dverí 1004	C10042X00	2,60 3,10



Povrch	typ prevedenia	obj. číslo	cena
IN	Zarážka dverí 2264	C2264EX00	3,60 4,30
OCS	Zarážka dverí 2264	C22649X00	3,60 4,30
OC	Zarážka dverí 2264	C22645X00	3,60 4,30
ONS	Zarážka dverí 2264	C22646X00	3,60 4,30
OFS	Zarážka dverí 2264	C22648X00	3,60 4,30
OLV	Zarážka dverí 2264	C22642X00	3,60 4,30



Povrch	typ prevedenia	obj. číslo	cena
IN	Zarážka dverí Ø 25	C1001EX00	3,60 4,30
OCS	Zarážka dverí Ø 32	C10019X00	5,20 6,20
OC	Zarážka dverí Ø 32	C10015X00	5,20 6,20
ONS	Zarážka dverí Ø 32	C10016X00	5,20 6,20
OFS	Zarážka dverí Ø 32	C10018X00	5,20 6,20
OLV	Zarážka dverí Ø 32	C10012X00	5,20 6,20



Zarážka

Okenná

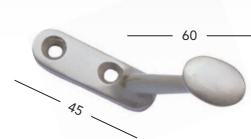

Povrch	typ prevedenia	obj. číslo	cena
OCS	Okenná zarážka	81990090	6,00 7,20
OC	Okenná zarážka	81990050	6,00 7,20
ONS	Okenná zarážka	81990060	6,00 7,20
OLV	Okenná zarážka	81990010	6,00 7,20
OLS	Okenná zarážka	81990030	6,00 7,20
BIELA	Okenná zarážka	81990070	6,00 7,20
IN	Podlažná zarážka	C161EX01	6,80 8,20

Podlažná



Piktogramy a číslica nalepovacie



Povrch	typ prevedenia	obj. číslo	cena
IN	Baby	CPIBABY	5,10 6,20
IN	Žena	CPIDAMA	5,10 6,20
IN	Muž	CPIPAN	5,10 6,20
IN	Pre invalidov	CPIINVAL	5,10 6,20
IN	Smer	CPISMER	5,10 6,20
IN	Sprcha	CPISPRCH	5,10 6,20
IN	Telefón	CPITELEF	5,10 6,20
IN	Zákaz fajčenia	CPINEKUR	5,10 6,20



Povrch	typ prevedenia	obj. číslo	cena
IN	„0“ 25 mm	C2183E00	1,20 1,40
IN	„1“ 25 mm	C2183E01	1,20 1,40
IN	„2“ 25 mm	C2183E02	1,20 1,40
IN	„3“ 25 mm	C2183E03	1,20 1,40
IN	„4“ 25 mm	C2183E04	1,20 1,40
IN	„5“ 25 mm	C2183E05	1,20 1,40
IN	„6“ 25 mm	C2183E06	1,20 1,40
IN	„7“ 25 mm	C2183E07	1,20 1,40
IN	„8“ 25 mm	C2183E08	1,20 1,40
IN	„9“ 25 mm	C2183E09	1,20 1,40
IN	„/“ 25 mm	C2183E10	1,20 1,40

Dverná sklápka

Povrch	typ prevedenia	obj. číslo	cena
OLV	Sklápka komplet A	M06042X0A	6,40 7,60
OLV	Sklápka komplet B	M06042X0B	6,40 7,60



Číslica nerez



Povrch	typ prevedenia	obj. číslo	cena
IN	„0“ 150x100x3 mm	C2180E00	5,20 6,20
IN	„1“ 150x100x3 mm	C2180E01	5,20 6,20
IN	„2“ 150x100x3 mm	C2180E02	5,20 6,20
IN	„3“ 150x100x3 mm	C2180E03	5,20 6,20
IN	„4“ 150x100x3 mm	C2180E04	5,20 6,20
IN	„5“ 150x100x3 mm	C2180E05	5,20 6,20
IN	„6“ 150x100x3 mm	C2180E06	5,20 6,20
IN	„7“ 150x100x3 mm	C2180E07	5,20 6,20
IN	„8“ 150x100x3 mm	C2180E08	5,20 6,20
IN	„9“ 150x100x3 mm	C2180E09	5,20 6,20
IN	„/“ 150x100x3 mm	C2180E11	5,20 6,20

Číslica



Povrch	typ prevedenia	obj. číslo	cena	Povrch	typ prevedenia	obj. číslo	cena	Povrch	typ prevedenia	obj. číslo	cena
ONS	„0“ 50 mm	C2150N0	1,40 1,70	OLV	„0“ 50 mm	C2150M0	1,40 1,70	OFS	„0“ 100 mm	C2160B0	3,40 4,10
ONS	„1“ 50 mm	C2150N1	1,40 1,70	OLV	„1“ 50 mm	C2150M1	1,40 1,70	OFS	„1“ 100 mm	C2160B1	3,40 4,10
ONS	„2“ 50 mm	C2150N2	1,40 1,70	OLV	„2“ 50 mm	C2150M2	1,40 1,70	OFS	„2“ 100 mm	C2160B2	3,40 4,10
ONS	„3“ 50 mm	C2150N3	1,40 1,70	OLV	„3“ 50 mm	C2150M3	1,40 1,70	OFS	„3“ 100 mm	C2160B3	3,40 4,10
ONS	„4“ 50 mm	C2150N4	1,40 1,70	OLV	„4“ 50 mm	C2150M4	1,40 1,70	OFS	„4“ 100 mm	C2160B4	3,40 4,10
ONS	„5“ 50 mm	C2150N5	1,40 1,70	OLV	„5“ 50 mm	C2150M5	1,40 1,70	OFS	„5“ 100 mm	C2160B5	3,40 4,10
ONS	„6“ 50 mm	C2150N6	1,40 1,70	OLV	„6“ 50 mm	C2150M6	1,40 1,70	OFS	„6“ 100 mm	C2160B6	3,40 4,10
ONS	„7“ 50 mm	C2150N7	1,40 1,70	OLV	„7“ 50 mm	C2150M7	1,40 1,70	OFS	„7“ 100 mm	C2160B7	3,40 4,10
ONS	„8“ 50 mm	C2150N8	1,40 1,70	OLV	„8“ 50 mm	C2150M8	1,40 1,70	OFS	„8“ 100 mm	C2160B8	3,40 4,10
ONS	„9“ 50 mm	C2150N9	1,40 1,70	OLV	„9“ 50 mm	C2150M9	1,40 1,70	OFS	„9“ 100 mm	C2160B9	3,40 4,10
ONS	„/“ 50 mm	C2150N/	1,40 1,70	OLV	„/“ 50 mm	C2150M/	1,40 1,70	OFS	„/“ 100 mm	C2160B/	3,40 4,10
OFS	„0“ 50 mm	C2150B0	1,40 1,70	ONS	„0“ 100 mm	C2160N0	3,40 4,10	OLV	„0“ 100 mm	C2160M0	3,40 4,10
OFS	„1“ 50 mm	C2150B1	1,40 1,70	ONS	„1“ 100 mm	C2160N1	3,40 4,10	OLV	„1“ 100 mm	C2160M1	3,40 4,10
OFS	„2“ 50 mm	C2150B2	1,40 1,70	ONS	„2“ 100 mm	C2160N2	3,40 4,10	OLV	„2“ 100 mm	C2160M2	3,40 4,10
OFS	„3“ 50 mm	C2150B3	1,40 1,70	ONS	„3“ 100 mm	C2160N3	3,40 4,10	OLV	„3“ 100 mm	C2160M3	3,40 4,10
OFS	„4“ 50 mm	C2150B4	1,40 1,70	ONS	„4“ 100 mm	C2160N4	3,40 4,10	OLV	„4“ 100 mm	C2160M4	3,40 4,10
OFS	„5“ 50 mm	C2150B5	1,40 1,70	ONS	„5“ 100 mm	C2160N5	3,40 4,10	OLV	„5“ 100 mm	C2160M5	3,40 4,10
OFS	„6“ 50 mm	C2150B6	1,40 1,70	ONS	„6“ 100 mm	C2160N6	3,40 4,10	OLV	„6“ 100 mm	C2160M6	3,40 4,10
OFS	„7“ 50 mm	C2150B7	1,40 1,70	ONS	„7“ 100 mm	C2160N7	3,40 4,10	OLV	„7“ 100 mm	C2160M7	3,40 4,10
OFS	„8“ 50 mm	C2150B8	1,40 1,70	ONS	„8“ 100 mm	C2160N8	3,40 4,10	OLV	„8“ 100 mm	C2160M8	3,40 4,10
OFS	„9“ 50 mm	C2150B9	1,40 1,70	ONS	„9“ 100 mm	C2160N9	3,40 4,10	OLV	„9“ 100 mm	C2160M9	3,40 4,10
OFS	„/“ 50 mm	C2150B/	1,40 1,70	ONS	„/“ 100 mm	C2160N/	3,40 4,10	OLV	„/“ 100 mm	C2160M/	3,40 4,10

Číslice a písmená kované

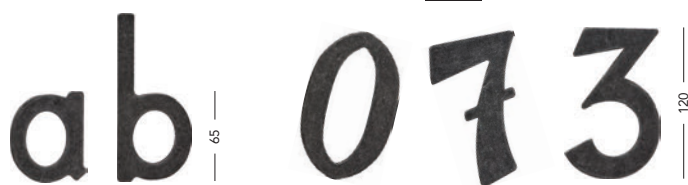

Povrch	typ prevedenia	obj. číslo	cena	Povrch	typ prevedenia	obj. číslo	cena
K	„A“ 120 mm	HA00A	11,60 13,90	K	„0“ 120 mm	HA000	11,60 13,90
K	„B“ 120 mm	HA00B	11,60 13,90	K	„1“ 120 mm	HA001	11,60 13,90
K	„C“ 120 mm	HA00C	11,60 13,90	K	„2“ 120 mm	HA002	11,60 13,90
K	„D“ 120 mm	HA00D	11,60 13,90	K	„3“ 120 mm	HA003	11,60 13,90
				K	„4“ 120 mm	HA004	11,60 13,90
				K	„5“ 120 mm	HA005	11,60 13,90
				K	„6“ 120 mm	HA006	11,60 13,90
				K	„7“ 120 mm	HA007	11,60 13,90
				K	„8“ 120 mm	HA008	11,60 13,90
				K	„9“ 120 mm	HA009	11,60 13,90

Vhod na listy

Povrch	typ prevedenia	obj. číslo	cena
ONS	Vittoria 255x74 mm	FB0255766	31,20 37,50
OFS	Vittoria 255x74 mm	FB0255768	31,20 37,50
OLV	Vittoria 255x74 mm	FB0255762	25,30 30,30
F1	Lida 255x80 mm	I02005	10,70 12,80
K	Bernard 285x85 mm	HA121009	37,20 44,70
K	Rustikal 285x85 mm	HA121007	37,20 44,70

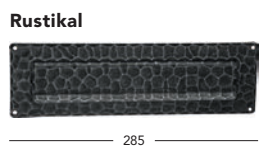
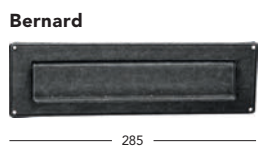

Prídavný retiazka a kukátko

Povrch	typ prevedenia	obj. číslo	cena
ONS	Retiazka	CRET06	5,10 6,20
OFS	Retiazka	CRET08	5,10 6,20
OLV	Retiazka	CRET02	5,10 6,20
OC	Kuk 3 14/35-60 mm	A4231	6,00 7,20
ONS	Kuk 3 14/35-60 mm	A42316	7,60 9,10
OLV	Kuk 3 14/35-60 mm	A1237	6,40 7,60
OC	Kuk 5 16/60-85 mm	A4233	9,80 11,80
ONS	Kuk 5 16/60-85 mm	A42336	10,70 12,80
OLV	Kuk 5 16/60-85 mm	A1482	10,70 12,80

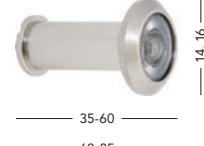

Klepadla

Anello



Ø 90, 110

Tirol



Ø 65, 95

Lev



Ø 90, 110, 150

150, 190, 260

Povrch	typ prevedenia	obj. číslo	cena
OLV	Anello Ø 90 mm	BE01102C00	42,40 50,80
OLV	Anello Ø 110 mm	BE01102B00	45,80 55,00
K	Tirol Ø 65 mm	HA115006	41,10 49,30
K	Tirol Ø 95 mm	HA115002	45,80 55,00
OFS	Lev 150x90 mm	BE0158P00	41,90 50,30
OLV	Lev 150x90 mm	BE0152P00	41,90 50,30
OFS	Lev 190x110 mm	BE0158M00	47,50 57,00
OLV	Lev 190x110 mm	BE0152M00	47,50 57,00
OFS	Lev 260x150 mm	BE0158G00	52,60 63,20
OLV	Lev 260x150 mm	BE0152G00	52,60 63,20

Konzola policová



Povrch	typ prevedenia	obj. číslo	cena
BIELA	100x75 mm 10 kg	CK100X075B	0,30 0,30
ČIERNA	100x75 mm 10 kg	CK100X075C	0,30 0,30
HNEDÁ	100x75 mm 10 kg	CK100X075H	0,30 0,30
SIVÁ	100x75 mm 10 kg	CK100X075S	0,30 0,30
BIELA	125x100 mm 12 kg	CK125X100B	0,30 0,40
HNEDÁ	125x100 mm 12 kg	CK125X100H	0,30 0,40
SIVÁ	125x100 mm 12 kg	CK125X100S	0,30 0,40
BIELA	150x125 mm 16 kg	CK150X125B	0,30 0,40
ČIERNA	150x125 mm 16 kg	CK150X125C	0,30 0,40
HNEDÁ	150x125 mm 16 kg	CK150X125H	0,30 0,40
SIVÁ	150x125 mm 16 kg	CK150X125S	0,30 0,40
BIELA	200x150 mm 20 kg	CK200X150B	0,50 0,60
ČIERNA	200x150 mm 20 kg	CK200X150C	0,50 0,60
HNEDÁ	200x150 mm 20 kg	CK200X150H	0,50 0,60

Povrch	typ prevedenia	obj. číslo	cena
BIELA	250x200 mm 24 kg	CK250X200B	0,60 0,70
ČIERNA	250x200 mm 24 kg	CK250X200C	0,60 0,70
HNEDÁ	250x200 mm 24 kg	CK250X200H	0,60 0,70
BIELA	300x250 mm 30 kg	CK300X250B	0,80 0,90
ČIERNA	300x250 mm 30 kg	CK300X250C	0,80 0,90
HNEDÁ	300x250 mm 30 kg	CK300X250H	0,80 0,90
SIVÁ	300x250 mm 30 kg	CK300X250S	0,80 0,90
BIELA	350x300 mm 34 kg	CK350X300B	1,00 1,20
ČIERNA	350x300 mm 34 kg	CK350X300C	1,00 1,20
HNEDÁ	350x300 mm 34 kg	CK350X300H	1,00 1,20
SIVÁ	350x300 mm 34 kg	CK350X300S	1,00 1,20

Háčik

S03



S05



S19



S06



S25



C317



55

42

Povrch	typ prevedenia	obj. číslo	cena
IN	Háčik S03	CS03F1-CP	7,30 8,70
IN	Háčik S05	CS05F1-CP	7,30 8,70
IN	Háčik S06	CS06F1-CP	7,30 8,70
IN	Háčik S19	CS19F1-CP	7,30 8,70
IN	Háčik S25	CS25F1-CP	7,30 8,70
OC	Háčik C317	C317	0,90 1,10
OFS	Háčik C517	C517	0,90 1,10
BIELA	Háčik C617	C617	0,90 1,10

Vešiak

Povrch	typ prevedenia	obj. číslo	cena
OCS	Vešiak 2217	C2217CX90	2,60 3,10
OC	Vešiak 2217	C2217CX10	2,60 3,10
ONS	Vešiak 2217	C2217CX40	2,60 3,10
OFS	Vešiak 2217	C2117CX30	2,60 3,10
OLV	Vešiak 2217	C2117CX20	2,60 3,10
ČIERNA	Vešiak 2217	C2117CX50	2,60 3,10
BIELA	Vešiak 2217	C2117CX60	2,60 3,10
OCS	Vešiak 2216	C2216CX90	3,90 4,70
OC	Vešiak 2216	C2216CX10	3,90 4,70
ONS	Vešiak 2216	C2216CX40	3,90 4,70
OFS	Vešiak 2216	C2216CX30	3,90 4,70
OLV	Vešiak 2216	C2216CX20	3,90 4,70
OCS	Vešiak 2108	C2108CX90	1,50 1,80
OC	Vešiak 2108	C2108CX10	1,50 1,80
ONS	Vešiak 2108	C2108CX40	1,50 1,80
OFS	Vešiak 2108	C2108CX30	1,50 1,80
OLV	Vešiak 2108	C2108CX20	1,50 1,80
ČIERNA	Vešiak 2108	C2108CX50	0,90 1,00
BIELA	Vešiak 2108	C2108CX60	1,50 1,80

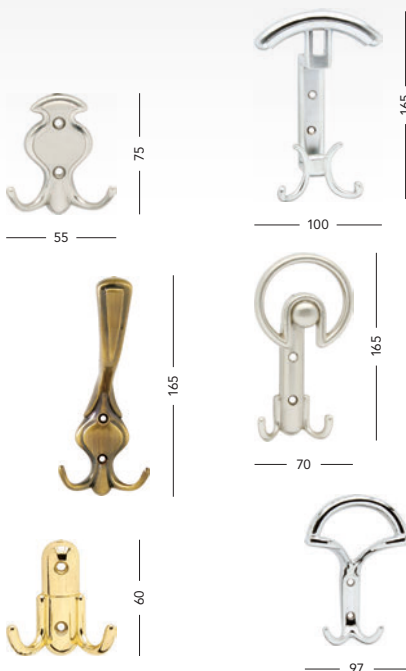

75

55

165

90

165

100

165

70

150

97

Povrch	typ prevedenia	obj. číslo	cena
OCS	Vešiak 2117	C2117CX90	5,10 6,20
OC	Vešiak 2117	C2117CX10	5,10 6,20
ONS	Vešiak 2117	C2117CX40	5,10 6,20
OFS	Vešiak 2117	C2117CX30	5,10 6,20
OLV	Vešiak 2117	C2117CX20	5,10 6,20
ČIERNA	Vešiak 2117	C2117CX50	4,70 5,60
BIELA	Vešiak 2117	C2117CX60	5,10 6,20
OCS	Vešiak 2105	C2105CX90	5,10 6,20
OC	Vešiak 2105	C2105CX10	5,10 6,20
ONS	Vešiak 2105	C2105CX40	5,10 6,20
OFS	Vešiak 2105	C2105CX30	5,10 6,20
OLV	Vešiak 2105	C2105CX20	5,10 6,20
ČIERNA	Vešiak 2105	C2105CX50	3,00 3,60
BIELA	Vešiak 2105	C2105CX60	5,10 6,20
OCS	Vešiak 2120	C2120CX90	3,70 4,50
OC	Vešiak 2120	C2120CX10	3,70 4,50
ONS	Vešiak 2120	C2120CX40	3,70 4,50
OFS	Vešiak 2120	C2120CX30	3,70 4,50
OLV	Vešiak 2120	C2120CX20	3,70 4,50
ČIERNA	Vešiak 2120	C2120CX50	2,70 3,20
BIELA	Vešiak 2120	C2120CX60	3,70 4,50

Vešiak

Povrch	typ prevedenia	obj. číslo	cena
OFS	Vešiak C001	C001	1,80 2,20
K	Vešiak C002	C002	1,20 1,50
OFS	Háčik C003	C003	0,90 1,10
K	Háčik C004	C004	0,90 1,10
OFS	Vešiak C005	C005	2,00 2,40
OFS	Háčik C006	C006	0,90 1,00
OFS	Vešiak C007	C007	2,00 2,40
OFS	Háčik C008	C008	0,80 1,00

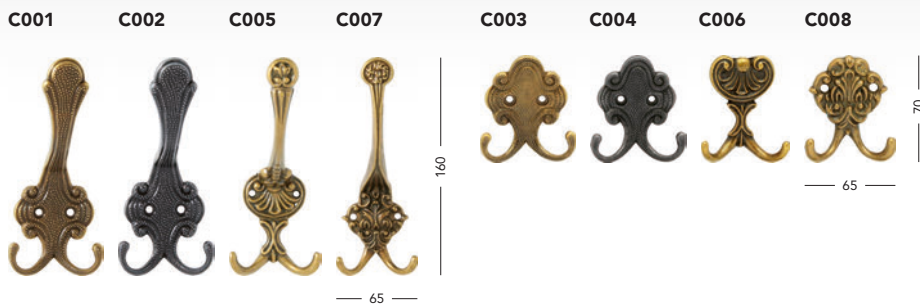

Vešiak s háčikmi

Povrch	typ prevedenia	obj. číslo	cena
OC	Vešiak 4 háčiky	CV77854	6,40 7,70
ONS	Vešiak 3 háčiky	CV77863	4,70 5,60
ONS	Vešiak 4 háčiky	CV77864	6,40 7,70
ONS	Vešiak 5 háčiků	CV77865	7,70 9,20



Držiak na kvetináč

Povrch	typ prevedenia	obj. číslo	cena
K	Držiak 170 mm	HA23301	15,00 18,00
K	Držiak 210 mm	HA23302	15,80 19,00



Petlice na dvere

Povrch	typ prevedenia	obj. číslo	cena
K	Petlice 200x65 mm	HA117003	41,50 49,80



Vešiaky kované

Povrch	typ prevedenia	obj. číslo	cena
K	H001 80x160 mm	HAH001	14,60 17,50
K	H003 60 mm	HAH003	3,90 4,70
K	H005 70x90 mm	HAH005	7,30 8,70
K	H009 70x210 mm	HAH009	8,10 9,80
K	H011 65x105 mm	HAH011	6,40 7,70
K	H014 170 mm	HAH014	4,70 5,60
K	H015 70x170 mm	HAH015	8,10 9,80
K	H023 80x85 mm	HAH023	9,40 11,30



Mechanická výsuvná prahová lišta

Název	obj. číslo	cena
Lišta mini 330 mm	PC-420M033	12,80 15,40
Lišta mini 430 mm	PC-420M043	13,30 15,90
Lišta mini 630 mm	PC-420M063	14,10 16,90
Lišta mini 830 mm	PC-420M083	15,40 18,50
Lišta mini 930 mm	PC-420M093	15,80 19,00
Lišta mini 1030 mm	PC-420M103	16,30 19,50
Lišta mini 1230 mm	PC-420M123	17,50 21,10
Lišta mini 1330 mm	PC-420M133	17,50 21,10

Lišta 430 mm	PC-T017043	19,30 23,10
Lišta 530 mm	PC-T017053	19,70 23,60
Lišta 630 mm	PC-T017063	20,50 24,70
Lišta 730 mm	PC-T017073	21,00 25,20
Lišta 830 mm	PC-T017083	21,80 26,20
Lišta 930 mm	PC-T017093	21,80 26,20
Lišta 1030 mm	PC-T017103	23,10 27,70
Lišta 1130 mm	PC-T017113	23,10 27,70
Lišta 1230 mm	PC-T017123	24,00 28,80
Lišta 1330 mm	PC-T017133	24,80 29,80



Posuvný systém

Povrch	typ prevedenia	obj. číslo	cena
IN	SN-150/50 s ložiskom	LE150X50L	31,20 37,50
IN	SN-180/50 s ložiskom	LE180X50L	32,50 39,00
IN	SN-200/50 s ložiskom	LE200X50L	34,70 41,60
IN	SN-150/100 s ložiskom	LE150X100	44,10 52,90
IN	SN-180/100 s ložiskom	LE180X100	48,80 58,60
IN	SN-200/100 s ložiskom	LE200X100	53,10 63,70

Tesniaca prahová lišta s gumou alebo kefkou

Povrch	typ prevedenia	obj. číslo	cena
BIELA	Guma 1000 mm	PC-1250B	9,00 10,80
HNEDÁ	Guma 1000 mm	PC-1250H	9,00 10,80
BIELA	Kefa 1000 mm	PC-1251B	9,00 10,80
HNEDÁ	Kefa 1000 mm	PC-1251H	9,00 10,80

Vetracie mriežky

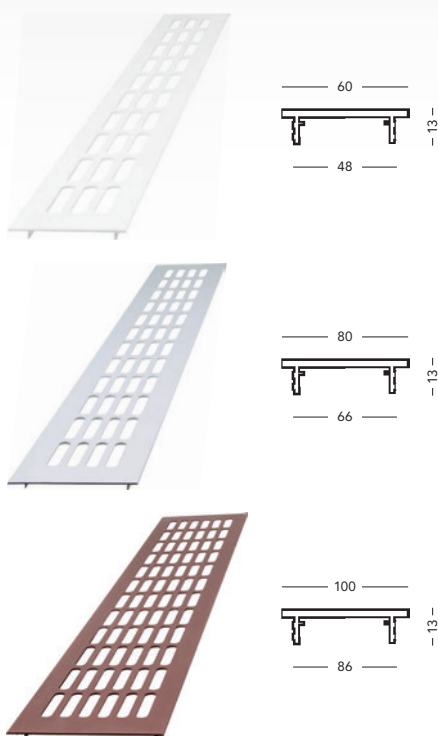

Povrch	typ prevedenia	obj. číslo	cena	
Biela	60x400 mm	CM0600400B	3,30	4,00
Hnedá	60x400 mm	CM0600400H	3,30	4,00
Strieborná	60x400 mm	CM0600400S	3,30	4,00
Zlatá	60x400 mm	CM0600400Z	3,30	4,00
Biela	60x500 mm	CM0600500B	3,90	4,70
Hnedá	60x500 mm	CM0600500H	3,90	4,70
Strieborná	60x500 mm	CM0600500S	3,90	4,70
Zlatá	60x500 mm	CM0600500Z	3,90	4,70
Biela	60x600 mm	CM0600600B	4,70	5,70
Hnedá	60x600 mm	CM0600600H	4,70	5,70
Strieborná	60x600 mm	CM0600600S	4,70	5,70
Zlatá	60x600 mm	CM0600600Z	4,70	5,70
Biela	60x800 mm	CM0600800B	6,30	7,60
Hnedá	60x800 mm	CM0600800H	6,30	7,60
Strieborná	60x800 mm	CM0600800S	6,30	7,60
Zlatá	60x800 mm	CM0600800Z	6,30	7,60
Biela	60x1000 mm	CM0601000B	7,30	8,70
Hnedá	60x1000 mm	CM0601000H	7,30	8,70
Strieborná	60x1000 mm	CM0601000S	7,30	8,70
Zlatá	60x1000 mm	CM0601000Z	7,30	8,70
Biela	80x400 mm	CM0800400B	3,90	4,70
Hnedá	80x400 mm	CM0800400H	3,90	4,70
Strieborná	80x400 mm	CM0800400S	3,90	4,70
Zlatá	80x400 mm	CM0800400Z	3,90	4,70
Biela	80x500 mm	CM0800500B	5,20	6,20
Hnedá	80x500 mm	CM0800500H	5,20	6,20
Strieborná	80x500 mm	CM0800500S	5,20	6,20
Zlatá	80x500 mm	CM0800500Z	5,20	6,20
Biela	80x600 mm	CM0800600B	6,20	7,40
Hnedá	80x600 mm	CM0800600H	6,20	7,40

Povrch	typ prevedenia	obj. číslo	cena	
Strieborná	80x600 mm	CM0800600S	6,20	7,40
Zlatá	80x600 mm	CM0800600Z	6,20	7,40
Biela	80x800 mm	CM0800800B	7,70	9,20
Hnedá	80x800 mm	CM0800800H	7,70	9,20
Strieborná	80x800 mm	CM0800800S	7,70	9,20
Zlatá	80x800 mm	CM0800800Z	7,70	9,20
Biela	80x1000 mm	CM0801000B	9,80	11,80
Hnedá	80x1000 mm	CM0801000H	9,80	11,80
Strieborná	80x1000 mm	CM0801000S	9,80	11,80
Zlatá	80x1000 mm	CM0801000Z	9,80	11,80
Biela	100x400 mm	CM1000400B	4,70	5,60
Hnedá	100x400 mm	CM1000400H	4,70	5,60
Strieborná	100x400 mm	CM1000400S	4,70	5,60
Zlatá	100x400 mm	CM1000400Z	4,70	5,60
Biela	100x500 mm	CM1000500B	6,40	7,70
Hnedá	100x500 mm	CM1000500H	6,40	7,70
Strieborná	100x500 mm	CM1000500S	6,40	7,70
Zlatá	100x500 mm	CM1000500Z	6,40	7,70
Biela	100x600 mm	CM1000600B	7,70	9,20
Hnedá	100x600 mm	CM1000600H	7,70	9,20
Strieborná	100x600 mm	CM1000600S	7,70	9,20
Zlatá	100x600 mm	CM1000600Z	7,70	9,20
Biela	100x800 mm	CM1000800B	9,80	11,80
Hnedá	100x800 mm	CM1000800H	9,80	11,80
Strieborná	100x800 mm	CM1000800S	9,80	11,80
Zlatá	100x800 mm	CM1000800Z	9,80	11,80
Biela	100x1000 mm	CM1001000B	12,00	14,40
Hnedá	100x1000 mm	CM1001000H	12,00	14,40
Strieborná	100x1000 mm	CM1001000S	12,00	14,40
Zlatá	100x1000 mm	CM1001000Z	12,00	14,40

Dverný zatvárač



Povrch	typ sily zatvárania	obj. číslo	cena	
Biela	TS1000 2/3	TS1000B	33,80	40,60
Hnedá	TS1000 2/3	TS1000H	33,80	40,60
Strieborná	TS1000 2/3	TS1000S	33,80	40,60
Biela	TS1000 + aretace	TS1000BAN	62,40	74,90
Hnedá	TS1000 + aretace	TS1000HAN	62,40	74,90
Strieborná	TS1000 + aretace	TS1000SAN	60,80	73,00

Povrch	typ sily zatvárania	obj. číslo	cena	
Biela	TS1500 3/4	TS1500B	55,60	66,70
Hnedá	TS1500 3/4	TS1500H	55,60	66,70
Strieborná	TS1500 3/4	TS1500S	55,60	66,70
Biela	TS1500 + aretace	TS1500BAN	75,60	90,70
Hnedá	TS1500 + aretace	TS1500HAN	75,60	90,70
Strieborná	TS1500 + aretace	TS1500SAN	75,60	90,70
Biela	TS2000 2/4/5	TS2000B	50,00	60,00
Hnedá	TS2000 2/4/5	TS2000H	50,00	60,00
Strieborná	TS2000 2/4/5	TS2000S	47,60	57,10
Biela	TS2000 + aretace	TS2000BAN	97,60	117,10
Hnedá	TS2000 + aretace	TS2000HAN	97,60	117,10
Strieborná	TS2000 + aretace	TS2000SAN	97,60	117,10
Biela	TS3000 1-4	TS3000B	131,60	157,90
Hnedá	TS3000 1-4	TS3000H	131,60	157,90
Strieborná	TS3000 1-4	TS3000S	131,60	157,90

Povrch	typ sily zatvárania	obj. číslo	cena	
Biela	TS3000 + aretace	TS3000BAN	162,20	194,70
Hnedá	TS3000 + aretace	TS3000HAN	162,20	194,70
Strieborná	TS3000 + aretace	TS3000SAN	162,20	194,70
Biela	TS4000 1-6/5-7	TS4000B	117,20	140,60
Hnedá	TS4000 1-6/5-7	TS4000H	117,20	140,60
Strieborná	TS4000 1-6/5-7	TS4000S	115,60	138,70
Biela	TS4000 + aretace	TS4000BAN	149,20	179,00
Hnedá	TS4000 + aretace	TS4000HAN	149,20	179,00
Strieborná	TS4000 + aretace	TS4000SAN	149,20	179,00
Biela	TS5000 5-6	TS5000B	226,40	271,70
Hnedá	TS5000 5-6	TS5000H	226,40	271,70
Strieborná	TS5000 5-6	TS5000S	226,40	271,70
Biela	TS5000 + aretace	TS5000BAN	255,60	306,70
Hnedá	TS5000 + aretace	TS5000HAN	255,60	306,70
Strieborná	TS5000 + aretace	TS5000SAN	255,60	306,70

Od modelu TS2000 sú zatvárače určené aj na protipožiarne a dymotesné dvere. Modely TS2000 TS4000 je možné za príplatok dodať aj s vypínacou aretáciou.

Dverný zatvárač



Parametry dverí			EN1154		
Váha	šírka	sila	Váha	šírka	sila
20 kg	do 750 mm	1	40 kg	750-850 mm	2
60 kg	850-950 mm	3	80 kg	950-1100 mm	4
100 kg	1100-1250 mm	5	120 kg	1250-1400 mm	6
160 kg	1400-1600 mm	7			

Od modelu TS73 sú zatvárače určené aj na protipožiarne a dymotesné dvere. Model TS73 je možné za príplatok dodať aj s vypínacou aretáciou.

Povrch	typ sily zatvárania	obj. číslo	cena	
Biela	TS68 2/3/4	TS68B	33,80	40,60
Hnedá	TS68 2/3/4	TS68H	33,80	40,60
Strieborná	TS68 2/3/4	TS68S	33,80	40,60
Biela	TS68 + aretace	TS68BA	55,20	66,30
Hnedá	TS68 + aretace	TS68HA	73,60	88,30
Strieborná	TS68 + aretace	TS68SA	55,20	66,30
Biela	TS73 2-4	TS73B	115,60	138,70
Strieborná	TS73 2-4	TS73S	115,60	138,70
Biela	TS73 + aretace	TS73BA	174,80	209,70
Strieborná	TS73 + aretace	TS73SA	174,80	209,70
Biela	TS92 2-4	TS92B	179,20	215,00
Strieborná	TS92 2-4	TS92S	179,30	215,20
Biela	TS92 + aretace	TS92BA	213,60	256,30
Strieborná	TS92 + aretace	TS92SA	213,60	256,30
Biela	TS93 2-5/5-7	TS93B	279,60	335,50
Strieborná	TS93 2-5/5-7	TS93S	279,60	335,50

Povrch	typ sily zatvárania	obj. číslo	cena	
Biela	TS93 + aretace	TS93BA	319,60	383,50
Strieborná	TS93 + aretace	TS92SA	319,60	383,50

Pružinový zatvárač

Povrch	typ prevedenia	obj. číslo	cena	
Strieborná	Pružinový zatvárač	56-01	31,60	37,90



Schodisko, stĺpiky

Povrch	typ prevedenia	obj. číslo	cena
IN	HR1815	CSHR1815	78,00 93,60
IN	HR1038	CSHR1038	74,00 88,80
IN	HR1031	CSHR1031	86,00 103,20
IN	HR1031 koncový	CSHR1031-K	78,00 93,60
IN	HR1031 rohový	CSHR1031-R	86,00 103,20

HR1815 HR1038 HR1031



Doplnkový materiál

Povrch	typ prevedenia	obj. číslo	cena
IN	Flexibilné spoj madla	CSW8560-42,4	27,40 33,10
IN	Aktívny spoj výpl. Ø 10 mm	CSW8342 D-10	7,60 9,10
IN	Spoj Ø 10 mm	CSW8322 D-10	3,60 4,30
IN	Zakončenie Ø 10 mm	CSB1002 D-10	3,60 4,30
IN	Upev. príruha výpl. Ø 10 mm	CSG8112	3,60 4,30
IN	Madlo Ø 10 mm	CSL8304-42-4	19,20 23,00
IN	Výplň Ø 10 mm, dĺžka 2 m	CSB1001D10-2M	7,60 9,10
IN	Záslepka Ø 42,4 mm M8	CSB8722	8,80 10,50

Jednotlivé typové riešenia nájdete na webe www.cobrask.sk/dokumenty

Držiak zábradlia

Povrch	typ prevedenia	obj. číslo	cena
IN	L8757	CSL8757	19,20 23,00
IN	L8758	CSL8758	23,20 27,80
IN	C2263 27	C2263EX27	9,00 10,80
IN	C2263 28	C2263EX28	9,00 10,80
IN	C2263 31	C2263EX31	9,00 10,80
OPS	M099	M09908X00	19,60 23,50
OLV	M099	M09902X00	19,60 23,50

L8757

L8758

C2263 27

C2263 28

C2263 31

M099



Cobra deťom

Kiddy

BB Červená	9,00	10,80
BB Žltá	9,00	10,80
BB Zelená	9,00	10,80
BB Modrá	9,00	10,80

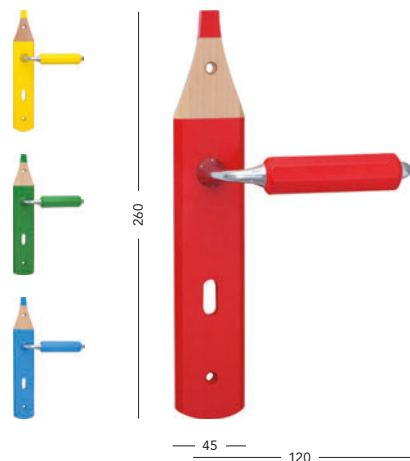

Filip-R

BB/PZ	25,20	30,20
WC	29,20	35,00
PZ LI/RE	31,20	37,40

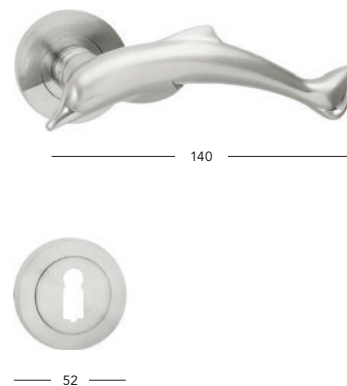

Detský vešiak

Povrch	typ a síla zavírání	obj. číslo	cena
Červená	Červený 4 háčiky	B223C00	10,70 12,80
Žltá	Žltý 4 háčiky	B223ZL00	10,70 12,80
Modrá	Modrý 4 háčiky	B223M00	10,70 12,80

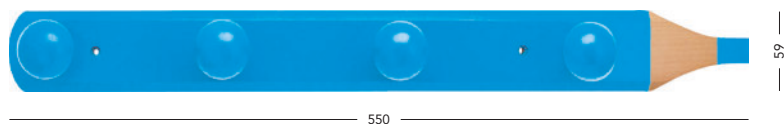

Krbové náradie

Povrch	typ prevedenia	obj. číslo	cena	
IN	Inox	KRBINOX	39,60	47,50
ČIERNA	Rustik	KRBRUSTIK	39,60	47,50
ČIERNA	Wood	KRBWOOD	26,40	31,70



Vrtacia šablóna



Názov	cena
Vrtacia šablóna	39,60 47,50

Panikové kovanie Dorma PHA 2000 strieborné



dĺžka držadla 1000 mm

certifikácia podľa EN 1125 a EN 179 pre kovanie EXITPAD

montáž na jednokrídlové a dvojkrídlové dvere

inštalácia bez zadlabávacej zámky

Súprava PHA 2000 – 1/1 na jednokrídlové dvere, 1-bodové uzamykanie

Panikové kovanie 1-bodové

	cena
	119,20 143,00

Súprava PHA 2000 – 1/3 na jednokrídlové dvere, 3-bodové uzamykanie

Panikové kovanie 3-bodové

Horné a spodné strelky čierne

Rozvorové ťahla strieborné

	cena
	119,20 143,00
	100,80 120,90
	43,20 51,80

Súprava PHA 2000 – 2/3 na jednokrídlové dvere, 3-bodové uzamykanie

Panikové kovanie 1-bodové

Panikové kovanie 2-bodové

Horné a spodné strelky čierne

Rozvorové ťahla strieborné

	cena
	119,20 143,00
	99,20 120,00
	100,80 120,90
	43,20 51,80

Súprava PUSHPAD 1/1 na jednokrídlové dvere, 1-bodové uzamykanie

Panikové kovanie EXITPAD, 1-bodové

	cena
	119,20 143,00

Súprava PUSHPAD 1/3 na jednokrídlové dvere, 3-bodové uzamykanie

Panikové kovanie EXITPAD, 3-bodové

Horné a spodné strelky čierne

Rozvorové ťahla strieborné

	cena
	119,20 143,00
	100,80 120,90
	43,20 51,80

Držadlá na panikové kovanie (nie sú súčasťou ponuky a musia sa uvádzať osobitne)

Oceľové držadlo strieborné, 1000 mm

	cena
	16,40 19,70

Vnútrotné kľučky k panikovému kovaniu (nie sú súčasťou ponuky a musia sa uvádzať osobitne)

Strieborný štít na uzamykateľnú kľučku pre cylindrickú polvložku

	cena
	71,60 85,90

Strieborný štít s guľou pre cylindrickú polvložku

	cena
	66,40 79,70



COBRA spol. s r.o.
Jeremiášova 2633/16b,
Praha 13 – Stodůlky,
Česká republika

Zákaznické centrum
Tel.: +421 245 944 581



